

2014
Parts Catalog
\$4.00

PICK UP TRUCKS
1957 - 1966

Early Ford

V-8 Sales, Inc.

Genuine Parts & Quality Reproductions

Fax Your Order 24hrs a Day: 1-864-845-7886

Information: 1-864-845-7878

Email: Earlyfordsouth@msn.com



Order Line: 1-864-845-7878



FLAT RATE SHIPPING

\$99 OR LESS SHIPS FOR \$10.00
\$100 OR MORE SHIPS FOR \$15.00
\$500 or More Ships for FREE!

**** See Shipping Page For More Details. ****

Visit our Website & Order From Our Complete On-Line Catalog @

WWW.EARLYFORD.COM

Providing Quality Service Since 1993

Early Ford V8 Sales Inc. was founded in 1993 and has been providing quality Ford auto parts and accessories to customers ever since. To date we have grown into a 12,000 squarefoot warehouse with over 10,000 items.

We are a full line provide of reproduction and original parts for 1928-1966 Ford passenger and pick up trucks.

Our entire catalog is now available online for your convenience. Search our extensive database of Ford products and accessories!

Our web site will help you learn more about our company, find answers to your most common questions, and order any of our over 10,000 parts and accessories.

If you don't see what you are looking for call us and ask. Our staff is always ready to assist you with technical questions.

Early Ford V-8 Sales, Inc. is a full line supplier of 1928 through 1966 early v-8 parts as well as Quality Model "A" Ford Parts. We publish four Catalogs as follows

Vintage Ford Center

1928-1931 Model "A" Parts

Early Ford V-8 Catalog

1932-1948 Passenger & 1932-1947 Pickup

Early Ford V-8 Catalog

1949-1959 Passenger & 1948-1956 Pickup

Early Ford V-8 Catalog

1957-1966 Pickup Trucks



*When you call during
Business hours you will
always speak to
knowledgeable
personnel.*

*No Phone Menus,
No Automated Responses.*

Contact information

OFFICE HOURS (Eastern Time)

Monday - Friday, 8 a.m. - 5 p.m.

Store sales during the above listed hours and by appointment at mutually convenient times on the weekends. Please call ahead to make sure we will be available.

TOLL FREE ORDER:.....800-417-3347

CUSTOMER SERVICE:.....864-845-7878

FAX:.....864-845-7886

EMAIL...

EARLYFORDSOUTH@MSN.COM

ORDER ON-LINE

WWW.EARLYFORD.COM

Call before 4:00 pm for *Same day shipping*. You may also fax your order using our convenient order form located in the back of the catalog.

Fax service is available 24 hours a day.

Early Ford V-8 Sales, Inc.

101 Hollow Drive

Piedmont, SC 29673

Contact Information



PAYMENT



We accept check, money orders, VISA, Mastercard and Discover. We will also ship UPS COD, however, there is an additional \$11.00 charge. There is a \$20.00 charge for any returned check.

SHIPPING

Orders are shipped via UPS, Fed Ex & USPS Priority Mail. Large items, such as front fenders are shipped via truck. Orders \$99.00 or less will ship for \$10.00. Orders \$100.00 or more will ship for \$15.00. Orders \$500 or more will ship for FREE! (Except fenders and oversize items.) Continental US only.

See our Shipping Information page for further details.

DAMAGE

Should a parcel be received with contents damaged or evidence that it had been opened and something is missing, notify the Carrier. Keep the parcel at the delivery address and do not destroy the carton. The Carrier will have a claims person come to view the package or have a driver pick it up and return it to their claims department. The Carrier will process your claim and contact us to arrange for another shipment.

GUARANTEE

All of our parts are guaranteed to satisfy if used as originally intended. All parts are guaranteed to be free of manufacturing defects. In any and all cases our liability shall not exceed the cost of the part purchased.

RETURN POLICY

Parts may be returned for any reason providing they have not been used or damaged by you, within 60 days of shipment for exchange, credit or refund. When returning a part please include a copy of the original invoice with a brief explanation as to why the part is being returned. Please contact us first before returning a part. COD returns will not be accepted.

PRICE CHANGES

Because our suppliers change prices throughout the year it may be necessary for us to change a price accordingly. If the new price is not acceptable to you please return the part for a complete refund.

PARTS

We buy as many American made parts as possible. We always put quality first when selecting any part and do our utmost to provide complete customer satisfaction. In addition to our reproduction parts we have a good selection of used and NOS parts. Please call or write with your needs. Our inventory is constantly expanding to better serve our customers and we are always interested in hearing from you as to how we can provide better service.

CAR SALES

Early Ford V-8 Sales always maintains an inventory of 6-12 *Top Quality Early Fords* for sale. If you are in the market for a car please visit our site at www.earlyford.com or call us direct. We also purchase Early Fords.

*Your business is greatly appreciated and we thank you.
Lou & Carole Grosso*

SHIPPING

FLAT RATE SHIPPING

ON ALL DOMESTIC GROUND ORDERS

* Restrictions Apply. See Additional Details Below*

Orders

\$99 or Less Will Ship for \$10.00

\$100 or More Will Ship for \$15.00

\$500 or More will Ship for FREE!

(Terms below apply)

These Rates Include Insurance & Handling.

This also includes orders that require multiple packages.

**This Only applies to Packages Shipped via Ground in the Contiguous US.
(This EXCLUDES Alaska, Hawaii, and Puerto Rico. Normal Carrier rates will apply.)

**International Service is not included. Customer will be charged Normal Carrier Rates.

**Packages requiring Additional Handling Do Not apply.

Oversized Packages or Items that can not be boxed will require special handling and will be shipped to customer at cost.

Example: Tail Pipes, Headliners, Tail Gates

**Items requiring Freight Truck Shipping will be billed at cost.

Any Flat Rate items purchased with at the same time will be included for the same Freight Truck Rate.

Example: Engines, Fenders, Truck Beds

**** Next Day Air, 2 day or 3 day Select is available upon request.
Customer will be charged Normal Carrier Rates.**

Our Preferred Carriers are listed Below.



TABLE OF CONTENTS

FRAME.....4

Wheel Parts, Brake Parts, Steering, Rear Axle,
Battery, Exhaust, Springs, Frame

MECHANICAL.....15

Motor/Engine, Transmission, Radiator/Grill,
Fuel System, Generator Starters

ELECTRICAL.....31

Ignition Headlights, Parking Lights, Tail lights,
Dome Lights, Horns Wiring Cigar

BODY.....43

Fenders, Running Board, Hood, Speedometer,
Mirrors Wipers Bumpers Shocks

CAB.....51

Firewall/Cowl, Windshield Radio, Glove Box,
Sunvisor, Floor Mat, Doors, Rear Window, Headliner

BED.....61

Bed Parts

MISCELLANEOUS.....64

Decals Books Bulbs Moldings Bolts, Motor Mount Kits,
Patch Panels, Key Chains, Electric Sign

INDEX OF PART GROUPS.....72

See the index for a detailed list of part groups
for quick page reference.

ORDERS ONLY 1-800-417-3347

WHEEL, HUB, DRUM & RELATED PARTS

<p>8A-1107 HUB BOLTS 49-70 2.50 ea</p> 	<p>B-1012 Lug Nut 1932-72 .70 ea.</p> 	<p>TAAA-1125-A Front Brake Drum -F100 1953-63 150.00 ea.</p> 
<p>C6TZ-1125-A Front Brake drum F1 p/up 11.09' cast 1964-67 54.95 ea.</p> 	<p>C4TZ-1126 Rear Brake Drum F1 1948-67 150.00 ea.</p> 	<p>6A-1130 Hub Cap F1 1948-60 30.00 ea.</p> 
<p>C6AZ-1130-G Hub Cap -15" dia.- Stainless & Black with Red center -Front & Rear -4 x 2 -Rear -4 x 4 1966-77 1966-77 95.00 ea.</p> 	<p>C7TZ-1130-H Hub Cap -Front - 4 x 4 -15" Anodized Aluminum 1966-77 95.00 ea.</p> 	<p>B5A-1131-A Front Hub Grease Cap -1 25/32" I.D. -F100 -4 x 2 1957-68 -F250 -4 x 2 1957-64 5.00 ea.</p> 
<p>LF-1131-A Front Hub Grease Cap -F250 -4 x 2 1965-72 3.50 ea.</p> 	<p>C6AZ-1141-A Hub Cap Plastic Cen- ter -Red -For C6AZ- 1130-G Hub Cap -Made from Original Tooling 1966-77 40.00 ea.</p> 	<p>C7TZ-1141-H Hub Cap Plastic Cen- ter -Red -For C7TZ- 1130-H Hub Cap- Made from Original Tooling 1966-77 40.00 ea.</p> 
<p>6A-18303-15 Outer Beauty Ring - 15" Wheels Has smooth contoured face -stainless steel 30.00 ea.</p> 	<p>6A-18303-16 Outer Beauty Ring - 16" Wheels Has smooth contoured face -stainless steel 30.00 ea.</p> 	

WHEEL AXLE BEARINGS & SEALS

<p>B2TZ-1175-A Rear Wheel Grease Retainer -F350 1957-64 5.00 ea.</p> 	<p>B7A-1177-A Rear Drum Grease Seal - 1 1/2" I.D. 2 1/2" O.D. 1957-67 5.00 ea.</p> 	<p>8M-1180 Rear Wheel Bearing Retainer 1948-70 12.00 ea.</p> 
<p>B7C-1190 Front Brake Drum Seal -F100 1957-64 3.95 ea.</p> 	<p>C7TZ-1190-D Front Brake Drum Seal -F100 1965-67 10.00 ea.</p> 	<p>B7C-1201-A Front Inner Wheel Bearing -F100 1957-67 10.00 ea.</p> 

WHEEL AXLE BEARINGS & SEALS *Continued*

<p>B-1202 <i>Front Wheel Outer Bearing Race</i> -Stamped 15250 -F500-600 1948-62 13.95 ea.</p> 	<p>B7C-1202-A <i>Front Inner Wheel Bearing Race</i> -F100 1957-67 8.00 ea.</p> 	<p>B7C-1203-S <i>Front Inner Bearing & Race Assembly</i> -F100 1957-67 14.00 ea.</p> 
<p>B5A-1216 <i>Front Outer Bearing - F100</i> 1957-67 9.50 ea.</p> 	<p>B5A-1217 <i>Front Outer Bearing Race - F100</i> 1957-67 8.00 ea.</p> 	<p>72054-S <i>Cotter Pin for Front Wheel</i> 1932-66 .25 ea.</p> 



BRAKE SHOES & LININGS - Does 1 Axle

<p>10-2001 <i>Front Brake Shoe & Lining Set - F1 - Four Pieces - 11" x 2</i> 1948-67 35.95 set</p> 	<p>55-2201 <i>Rear Brake Shoe & Lining Set - F1 Four Pieces - 11" x 2</i> 1948-67 24.95 set</p> 
--	--

MISCELLANEOUS BRAKE PARTS

<p>B5A-2049 <i>Brake Adjusting Screw Spring F1</i> 1948-63 8.00 ea.</p> 	<p>CISS-2049 <i>Brake Adjusting Screw Spring - Front or Rear - F100</i> 1964-72 12.50 ea.</p> 	<p>B5A-2041-S <i>Star Wheel Adjusting Screw Assembly - F1</i> 1948-60 14.00 ea.</p> 
<p>7C-2065-S <i>Brake Shoe Hold Down Kit - F1</i> 1948-60 10.00 kit</p> 	<p>C4TZ-2065-S <i>Brake Shoe Hold Down Kit - F1</i> 1964-67 17.00 kit</p> 	<p>8A-2091 <i>Parking Brake Cable Adjusting Nut - F100-250</i> 1957-60 5.25 ea.</p> 
<p>91A-2106 <i>Emergency Brake Arm Clip - (2)per truck</i> 1948-72 .75 ea.</p> 	<p>91A-2151 <i>Brass Inlet Washer for Master Cyl.</i> 1957-60 1.00 ea.</p> 	<p>91A-2152 <i>Brass Outlet Washer for Master Cyl.</i> 1957-60 1.00 ea.</p> 

BRAKE RETRACTING SPRING

<p>B5A-2035 <i>Brake Retracting Spring - (2)per wheel</i> 1948-63 2.00 ea.</p> 	<p>COMM-2036-A <i>Brake Retracting Spring - F100 Primary - (1)per wheel</i> 1964-72 4.00 ea.</p> 	<p>COMM-2035-A <i>Brake Retracting Spring - F100 Secondary - (1)one per wheel</i> 1964-72 4.00 ea.</p> 
--	--	--

ORDERS ONLY 1-800-417-3347

WHEEL CYLINDER ASSEMBLY







<p>8C-2061 <i>Right Front Wheel Cylinder Assembly - F1 1948-60 26.95 ea.</i></p> 	<p>8C-2062 <i>Left Front Wheel Cylinder Assembly - F1 1948-60 26.95 ea.</i></p> 	<p>C5AZ-2061-A <i>Right Front Wheel Cylinder Assembly F1 1961-64 29.95 ea.</i></p> 
<p>C5AZ-2062-A <i>Left Front Wheel Cylinder Assembly F1 1961-64 29.95 ea.</i></p> 	<p>8A-2261 <i>Right Rear Wheel Cylinder Assembly - F1-7/8 1955-72 22.50 ea.</i></p> 	<p>8A-2262 <i>Left Rear Wheel Cylinder Assembly - F1 -7/8 1955-72 22.50 ea.</i></p> 
<p>TCAA-2261-A <i>Right Rear Wheel Cylinder -1 1/4" Dia.- F350 1953-66 32.50 ea.</i></p> 	<p>TCAA-2262-A <i>Left Rear Wheel Cylinder - 1 1/4" Dia.- F350 1953-66 32.50 ea.</i></p> 	<p>CITT-2062-E <i>Left Front Wheel Cylinder Assembly -F100 Before Serial -#260,001 1961-62 & 64 29.95 ea.</i></p> 
<p>CITT-2061-E <i>Right Front Wheel Cylinder Assembly F100 -Before Serial -#260,001 1961-62 & 64 29.95 ea.</i></p> 	<p>C5TZ-2062 <i>Left Front Wheel Cylinder Assembly - F100 1965-67 48.00 ea.</i></p> 	<p>C5TZ-2061 <i>Right Front Wheel Cylinder Assembly - F100 1965-67 48.00 ea.</i></p> 

WHEEL CYLINDER REPAIR KITS

1 Kit does 1 Wheel

<p>A8C-2221 <i>Front Wheel Cylinder Repair Kit, - F100 -ex.1963 1948-67 3.95 ea.</i></p> 	<p>8A-2128 <i>Rear Wheel Cylinder Repair Kit - 7/8 -F100 -ex.1963 1955-72 3.50 ea.</i></p> 
<p>C1TZ-2221-A <i>Rear Wheel Cylinder Repair Kit - 1 1/8" Dia.-F250 -ex.1963 1957-64 8.00 ea.</i></p> 	<p>C4TZ-2221-C <i>Brake Wheel Cylinder Repair Kit - For front brakes - 1 1/8" dia.-B-C-F-N600-950 1964-72 10.00 ea.</i></p> 

BRAKE HOSES

<p>8A-2078 Rear Brake Hose -F100 - 17 1/2" long 1948-60 13.95 ea.</p> 	<p>B7C-2078 Front Brake Hose -F100 - 16 1/16" long 1957-60 14.95 ea.</p> 	<p>C3TZ-2078-C Front Brake Hose -23 1/4" long -F600-950 1961-66 14.50 ea.</p> 
<p>C1TT-2282-C Rear Brake Hose - 1/2 Ton P/up 2WD 1961-65 17.50 ea.</p> 	<p>C5TZ-2078 Front Brake Hose - F100 - 17 3/4" long 1965-71 36.00 ea.</p> 	
<p>C5TZ-2078-B Front Brake Hose - 18 5/8" long - F350 1965-66 19.00 ea.</p> 	<p>C5TZ-2282 Rear Brake Hose - F100 - 18 5/8" long 1966-72 46.00 ea.</p> 	

BRAKE ADJUSTING HOLE COVER

<p>H-2092 Brake Adjusting Hole Cover - Steel 1948-63 3.00 ea.</p> 	<p>8A-2092 Brake Adjusting Hole Cover - Rubber 1964-72 .75 ea.</p> 
--	--

MASTER CYLINDER ASSEMBLY



<p>B9C-2140 Master Cylinder Assembly - F100 1957-60 79.95 ea.</p> 	<p>C3TZ-2140-H Master Cylinder Assembly - F100 1961-66 74.95 ea.</p> 
---	---



MASTER CYLINDER REPAIR KIT

<p>B9C-2004 Master Cylinder Repair Kit - F100 1957-60 19.95 ea.</p> 	<p>B9D-2004-A Master Cylinder Repair Kit - F250(4x2)& (4x4) B500-600 1957-60 12.00 ea.</p> 	<p>C1TZ-2004 Master Cylinder Repair Kit 1961-66 27.50 ea.</p> 
<p>1A-2162-A Master Cylinder Cap -Metal - F100-850 1953-60 13.50 ea.</p> 	<p>C5ZZ-2162-B Master Cylinder Filler cap with Gasket -screw on type 1961-66 25.00 ea.</p> 	<p>8M-2167 Master Cylinder Cap Gasket - F100- F-800 1953-62 2.75 ea.</p> 

ORDERS ONLY 1-800-417-3347

FRONT PARKING BRAKE CABLE

<p>B9TT-2853-K Front Parking Brake Cable & Housing Assembly - 80-1/2" Long for 110" Wheel Base F100 1957-60 89.00 ea.</p> 	<p>8M-2814 Park Brake Cable Clip -Original Tooling 1957-64 2.00 ea.</p> 	<p>B9TT-2853-L Front Parking Brake Cable & Housing Assembly - 118" Wheel Base -88 1/2" Long - F-100, F250 1957-60 89.00 ea.</p> 
--	--	--

<p>C1TT-2853-AA Front Parking Brake Cable & Housing Assembly - 80-3/4" Long for F100 -250 4 x 2 1961-64 65.00 ea.</p> 	<p>C5TZ-2853-P Front Parking Brake Cable & Housing Assembly - 98" long -for F100 -250 4 x 2 1965-66 65.00 ea.</p> 
--	---



REAR PARKING BRAKE CABLE

<p>TAAA-2275-A Rear Parking Brake Cable & Housing Assembly F100 135-1/2" Long -(1 required)-F250 1953-60 33.50 ea.</p> 	<p>C1TT-2635-B Rear Parking Brake Cable & Housing Assembly F100, F250 70" Takes (2) 1961-64 65.00 ea.</p> 
<p>C5TZ-2A635-C Left Rear Parking Brake Cable & Housing Assembly F100 (55") 1965-66 55.00 ea.</p> 	<p>C5TZ-2A635-D Right Rear Parking Brake Cable & Housing Assembly -F100 (61") 1965-66 55.00 ea.</p> 

CLUTCH, BRAKE PEDAL & RELATED PARTS

<p>B9A-2454-A Parking Brake Pedal Pad - For trucks with tilt cabs 1963-72 8.00 ea.</p> 	<p>B7C-2457-PR Clutch & Brake Pedal Pads 1957-62 14.00 pr.</p> 	<p>B7A-2457-A Clutch & Brake Pedal Pad - F100, F250 1963-67 5.00 ea.</p> 
<p>B7C-2461-A Brake & Clutch Pedal Bushing in plastic, 2 per pedal, F100-F350 1957-65 8.00 ea.</p> 	<p>B7AZ-2471-A Clutch & Brake Pedal Bushing - 2 per pedal -F100 1966-72 1.00 ea.</p> 	<p>B2A-2474-A Brake & Clutch Master Cyl.Push Rod Bushing 1/8" long, F100-F350 1957-64 5.00 ea.</p> 
<p>MA-7583-A Brake Pedal Arm Bumper - F100, F1100 1957-66 2.50 ea.</p> 	<p>B7A-2628-B Parking Brake Equilizer Rod 1961-66 10.00 ea.</p> 	

AXLE BUMPERS

<p>B7C-3020 <i>Front & Rear Axle Bumper -</i> F100, F250, F350 1957-60 7.00 ea.</p> 	<p>C5TZ-3020-A <i>Front Axle Bumper</i> -F100-350 1965-79 15.00 ea.</p> 	<p>C5TZ-4730-B <i>Rear Axle Bumper -</i> 2 per truck - 4 x 2 - F100/350 2 per truck -4 x 4 -F100/250 1965-72 20.00 ea.</p> 
--	--	---

KING PIN BOLT SET



Spindle Bolt & Bushing Kits -Kit is for BOTH sides

<p>B7C-3111-A <i>King Pin Bolt Set -</i> F100 1957-64 50.00 kit</p> 	<p>B7Y-3111-A <i>King Pin Bolt Set -</i> 3.8m Front Axle - F350 1957-66 35.00 set</p> 
<p>C5TZ-3111-C <i>King Pin Bolt Set -</i> F100 1965 60.00 kit</p> 	<p>C8TZ-3111-A <i>King Pin Bolt Set -</i> F100 1966-71 60.00 kit</p> 

TIE ROD ENDS

<p>TAAA-3281 <i>Tie Rod Tube -</i> F100, F250 1953-60 64.95 ea.</p> 	<p>11A-3289 <i>Tie Rod End -</i> <i>Right Hand Threads</i> Fits All 1/2 Ton - w/seal & grease fitting 1935-64 15.00 ea.</p> 	<p>11A-3290 <i>Tie Rod End -</i> <i>Left Hand Threads -</i> Fits All 1/2 Ton - w/seal & grease fitting 1935-64 15.00 ea.</p> 
<p>11A-3270/71-SET <i>11A-3270 & 11A-3271</i> <i>Right & Left</i> 1935-64 18.95 set</p> 	<p>C5TZ-3A130-A <i>Left Inner Tie Rod End</i> 1965-71 48.25 ea.</p> 	

FRONT AXLE PIVOT BUSHING & RADIUS ROD BUSHINGS

<p>C5TZ-3B177-A <i>Front Axle Pivot Bushing</i> <i>(Twin I Beam)-</i> 2 per truck -F100 1965-72 15.00 ea.</p> 	<p>C5TZ-3B203-B <i>Front Radius Rod Bushing -Rear -</i> 2 per truck - F100 1965-72 6.50 ea.</p> 	<p>C5TZ-3B203-C <i>Front Radius Rod Bushing -Front -</i> 2 per truck - F100 1965-72 6.50 ea.</p> 
--	--	---

ORDERS ONLY 1-800-417-3347

FRONT AXLE PIVOT BUSHING & RADIUS ROD BUSHINGS Continued

C7TZ-3B203-A Front Radius Rod Bushing -
 Front & Rear -4 per truck -
 F350 1965-72
 6.50 ea.



D6TZ-3B203-A Radius Rod Bushing on Axle End
 for 4x4 -Takes 2 per Side
 1966-79
 6.50 ea.



FRONT AXLE AND RADIUS ARM KIT -SAVE, BUY A KIT

C5TZ-3B203-KIT Radius Arm Bushing Kit
 w/Axle Pivot Bushing -
 F100-250 Includes:(2)C5TZ-3B177-A,
 (2)C5TZ-3B203-C, (2)C5TZ-3B203-B
 1965-72
 50.00 kit



D2TZ-3B203-KIT Radius Arm Bushing Kit -
 F100, 4 x 4
 Includes:(4)D6TZ-3B203-A,
 (4) C5TZ-3B203-C
 1966-72
 50.00 kit



DRAG LINKS

C5TZ-3304-C Drag Link Assembly -
 Before Ser.#M00,001
 1965-71
 175.00 ea.



STEERING COLUMN TO FLOOR SEALS

C1TZ-3513 Steering Column to Floor Seal -
 Rubber
 1961-64
 12.00 ea.



B7C-3513 Steering Column to Floor Seal -
 Rubber
 1957-60
 5.00 ea.



STEERING PARTS

Please refer to the assembly picture on the NEXT page.

C5DZ-3511-A Steering Column
 Tube Flange Plate
 for Manual Trans-
 mission -F100-350
 1965-72
 30.00 ea.



C3DZ-3517-A Upper & Lower Steer-
 ing Column Bear-
 ing -4 x 2 F-100,
 F-250
 1957-66
 17.50 ea.



B1AZ-3518-A Upper & Lower Steer-
 ing Column Bearing
 Sleeve Plastic F100-
 600
 1957-66
 15.00 ea.



8M-3520 Upper Steering
 Column Bearing
 Spring
 1949-60
 2.50 ea.



B7C-3524-A Steering Worm Shaft
 -F100, F250
 1957-60
 200.00 ea.



B7C-3524-X Worm Gear only
 1953-60
 64.95 ea.



C1TT-3524-C Steering Worm and
 Shaft -N.O.S.-
 F100-350 (4x4)
 1961-63
 200.00 ea.



C5TZ-3A525-A Steering Column Gear
 Input Shaft Coupling
 -F100-350
 1965
 30.00 ea.





B-3552 Upper Race -F100,
 F250
 1948-60
 11.50 ea.



STEERING PARTS

<p>8A-3553 <i>Lower Race -</i> <i>F100, F250</i> <i>1948-60</i> <i>29.90 ea.</i></p> 	<p>68-3571-A <i>Steering Worm Roller</i> <i>Bearing -Need Two</i> <i>-</i> <i>F100, F250</i> <i>1948-60</i> <i>10.95 ea.</i></p> 	<p>B7C-3576-A <i>Steering Sector Shaft</i> <i>Bushing -</i> <i>Need Two -</i> <i>F100, F250</i> <i>1957-60</i> <i>2.50 ea.</i></p> 
<p>7C-3581 <i>Steering Box Gasket</i> <i>Set -F1, F2</i> <i>1948-60</i> <i>9.00 kit</i></p> 	<p>8M-3591 <i>Sector Shaft Seal</i> <i>-F100, F250, F350</i> <i>1953-60</i> <i>4.50 ea.</i></p> 	<p>TAAA-3693 <i>Steering Column Anti-Squeak</i> <i>1953-60</i> <i>3.00 ea.</i></p> 
<p>21C-3738-A <i>Steering Shaft Felt Seal -</i> <i>Comes in Gasket kit #7C-3581</i> <i>1948-60</i> <i>2.00 kit</i></p> 	<p>359553-S <i>Steering Wheel Nut -</i> <i>F100, F600</i> <i>1948-62</i> <i>3.95 ea.</i></p> 	

STEERING WHEEL

<p>B6C-3600-B <i>Steering Wheel -</i> <i>w/o horn button -3 spoke, black -</i> <i>18" O.D.</i> <i>1956-60</i> <i>225.00 ea.</i></p> 	<p>C3DZ-3600-A <i>Steering Wheel -3 spoke in Black -</i> <i>17" O.D.-F100-350 -w/o horn button</i> <i>1961-70</i> <i>225.00 ea.</i></p> 
---	--

B6C-3600-B





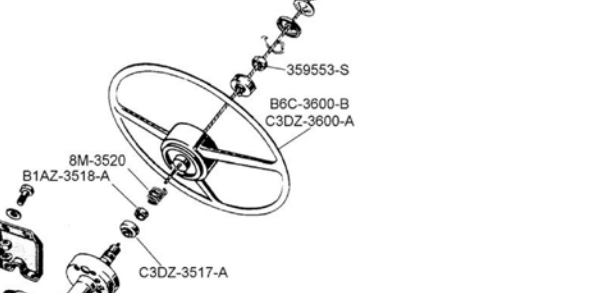

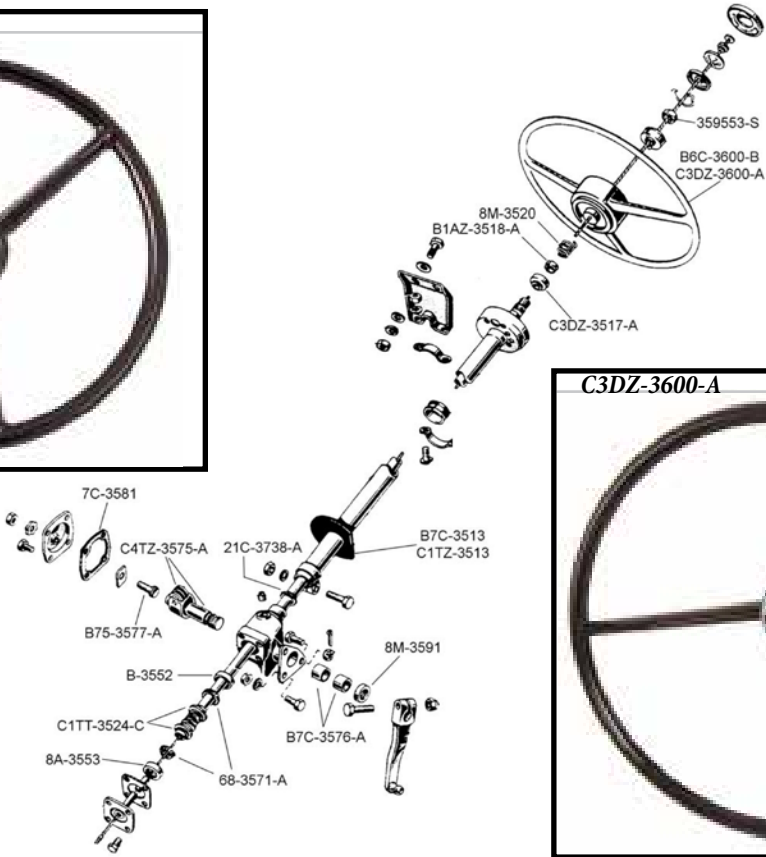



C3DZ-3600-A



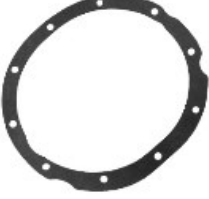



ORDERS ONLY 1-800-417-3347

HORN PARTS		
<p>7RC-3631 <i>Horn Contact Plate</i></p> <p><i>-F100-350</i> 1948-60 6.00 ea.</p> 	<p>BAAA-3627 <i>Painted White</i></p> <p><i>Horn Button -</i> <i>Original Tooling</i> 1953-60 50.00 ea.</p> 	<p>BAAA-3627-SS <i>Polished Stainless</i></p> <p><i>Horn Button -Original Tooling</i> 1953-60 50.00 ea</p> 
<p>BAAA-3627-A <i>Anniversary Edition</i></p> <p><i>Horn button</i> 1953-64 62.50 ea</p> 	<p>B6C-3627-A <i>Painted Red Horn Button -</i></p> <p><i>Original Tooling</i> 1953-60 50.00 ea.</p> 	
<p>C3TZ-3649-B <i>Steering Wheel Hub Emblem -</i></p> <p><i>"Ford" Plastic -4 x 2 -F100/250 -</i> 1961-67 30.00 ea.</p> 	<p>C2DZ-13A809-A <i>Horn Button Index -</i></p> <p><i>F100-300 -Except 4-wheel Drive</i> 1961-66 6.00 ea.</p> 	
KEY BLANKS		
<p>BA-3685-A <i>Ford Ignition & Door Key Blank -</i></p> <p>1953-66 4.50 ea.</p> 	<p>BA-3685-ANV <i>Anniversary Key Blank</i></p> <p><i>Ign. Only -</i> 1953-66 10.00 ea.</p> 	
REAR AXLE PARTS		
<p>B7A-4035 <i>Differential Housing</i></p> <p><i>Gasket -</i> <i>F100</i> 1957-66 8.00 ea.</p> 	<p>B8AZ-4209-C <i>Differential Ring Gear</i></p> <p><i>and Pinion Set - 3.25</i> <i>ratio -</i> <i>9" Ford rear end</i> <i>-F100</i> 1957-72 322.00 set</p> 	<p>B7A-4221-A <i>Differential Carrier</i></p> <p><i>Bearing -</i> <i>Stamped LM-501349</i> <i>-F100 -</i> <i>For differentials with</i> <i>medium carrier bear-</i> <i>ings</i> 1959-68 12.00 ea.</p> 
<p>B7A-4222-A <i>Differential Car-</i></p> <p><i>rier Bearing Race</i> <i>- Stamped</i> <i>LM-501310 -</i> <i>F100 -For differen-</i> <i>tials with medium</i> <i>carrier bearings</i> 1959-68 6.00 ea.</p> 	<p>B7A-4676-A <i>Drive Pinion Seal</i></p> <p><i>-Used with</i> <i>4" pinion seal</i> 1957 15.00 ea.</p> 	<p>B8A-4676-B <i>Drive Pinion Seal</i></p> <p><i>-Used with</i> <i>3" pinion seal</i> 1957-62 14.00 ea.</p> 
<p>8M-2245 <i>Wheel Bearing</i></p> <p><i>Retainer to</i> <i>Backing Plate</i> <i>Gasket</i> 1948-66 4.50 ea.</p> 	<p>8M-2245-A <i>Rear Axle</i></p> <p><i>Housing to Backing</i> <i>Plate Gasket</i> 1948-66 4.50 ea.</p> 	<p>8M-1225-B <i>Rear Axle Bearing</i></p> <p><i>-F1</i> 1948-70 45.00 ea.</p> 

TAILPIPE

	B5C-5255-A Tailpipe -Short Type - 6 & 8 cyl.223, 262, 240, 292, 300 - F100-350 1954-66 24.95 ea.
---	---

EXHAUST DEFLECTORS

	51A-18259-A Stainless Steel Exhaust Deflector -Ford Script - All 18.00 ea.
---	--

	51A-18259-B Stainless Steel Exhaust Deflector -V-8 - All 18.00 ea.
---	--

	51A-18259-C Stainless Steel Exhaust Deflector -Plain All 18.00 ea.
---	--

CAB TO FRAME MOUNTING KIT

	B7C-5400-S Cab to Frame Pad & Bolt Kit -F100 Not for 4 x 4 1957-60 50.00 kit
---	--

	CITZ-5400-S Cab to Frame Pad & Bolt Kit -F100 Not for 4 x 4 1961-64 60.00 kit
---	---

	C5TZ-5400-S Cab to Frame Pad & Bolt Kit -F100 Not for 4 x 4 1965-66 100.00 kit
---	--

FRONT SPRING SHACKLE KIT-1957-60

	APA-5631 Front Spring Shackle Kit -Front -F100, F250 -Includes one #1A-5267-A bar, one #AB-5713-A or B shackle -four #8A-5719 bushings, & two #34445-S2 lock nuts -need two kits per pickup 1957-60 15.00 kit
---	--

	B7C-5304-A Front Spring Shackle Kit - Rear -F100, F250 - Includes one #B6S-5781-A bushing, one #B7TZ-5465-A bolt -one#34447-S2 nut -Need two kits per pickup 1957-60 10.00 kit
---	---

	B7C-5300-S Front Spring Shackle Kit - Both Springs -F100, F250 Includes two #APA-5631 & two #B7C-5304-A 1957-60 79.95 kit
--	---

PINS & BUSHINGS -F100 & F250 FRONT SPRINGS



	8A-5334-S Spring Clamp Liner -Rubber -Set of six - Front spring takes eight pieces for both sides - Rear spring takes four pieces for both sides 1957-60 8.00 kit
---	---

	CITT-5468-D Front Spring Shackle Inner Bar -F100-250 (120" WB 4x4) 1961-64 F350-700 1961-62 F350 1963-64 1961-64 10.00 ea.
---	--

	CITT-5469-B Front Spring Shackle Outer Bar -120" W.B. 4 x 4 - F100/250 1961-64, F350/700 1961-62, F350 1963-64 1961-64 10.00 ea.
--	--

ORDERS ONLY 1-800-417-3347



PINS & BUSHINGS -F100 & F250 FRONT SPRINGS Continued

<p>8A-5719 <i>Bushing -Front -Need eight</i> 1957-60 2.00 ea.</p> 	<p>B6S-5781-A <i>Bushing -Rear -Need two</i> 1957-60 12.00 ea.</p> 	<p>B7TZ-5465-A <i>Rear Bushing Pin -Need two</i> 1957-60 2.00 ea.</p> 
---	--	---

FRONT SHACKLE KIT & RELATED PARTS -1961-1964

<p>C1TZ-5304-G <i>Front Spring Shackle Kit - Front of Spring -F100, F250,</i> <i>Includes one each of: #C1TT-5348-B Bushing-Upper, #B7TZ-5465-A Bolt, #C1TT-5781-D Bushing-Lower, #374727-S8 Bolt, one nut, two lock washers and two #C1TT-5468-E Bars, Need two kits per pickup</i> 1961-64 60.00 kit</p> 
--

FRONT SHACKLE KIT & RELATED PARTS -1961-1964

<p>C1TZ-5304-E <i>Front Spring Shackle Kit - Rear of Spring -F100, F250,</i> <i>Includes one each of #C1TT-5348-A Bushing, #374727-S8 bolt, One lock washer, and one nut - Need two kits per pickup</i> 1961-64 59.50 kit</p> 	<p>C1TZ-5300-S <i>Front Spring Shackle Kit - Both Springs -F100, F250, - Includes Two each of #C1TZ-5304-G & #C1TZ-5304-E</i> 1961-64 200.00 kit</p> 
--	--

REAR SPRING SHACKLE KIT

<p>B7C-5630-A <i>Front of Rear Spring Shackle Kit - Front -F100, - Includes one each of #B7C-5781-A Bushing, #359242-S Bolt,, #34426-S Nut -Need Two kits per pickup</i> 1957-67 17.50 kit</p> 	<p>B7TZ-5630-A <i>Rear of Rear Spring Shackle Kit - Front -F100, Includes one each of #B7C-5776-A Shackle, #B7C-5781-A, Bushing, Two each of #359242-S Bolts, & #34426-S Nuts, Does one Spring</i> 1957-64 40.00 kit</p> 
--	---

REAR SPRING PINS & BUSHINGS

<p>C1TT-5776-A <i>Rear Spring Rear Shackle -F350</i> 1961-63 25.00 ea.</p> 	<p>B7C-5781-A <i>Bushing for Front & Rear -F100 -Need four</i> 1957-64 9.50 ea.</p> 	<p>C5TZ-5781-A <i>Rear Spring Front & Rear Bushing -Need 4 -F250 (4x2) 1964-66, Need 2 -F250 (4x4) 1966, Need 2 -F350, 1966</i> 1964-66 8.00 ea.</p> 
--	---	--

REAR SPRING PINS & BUSHINGS Continued

<p>359242-S2 Bolt for Rear Bushings - Need four (Same as #358955-S) 1957-60 5.00 ea.</p> 	<p>359242-S2 Bolt for Front Bushings - Need two 1957-64 5.00 ea.</p> 	<p>379668-S Bolt for Front & Rear of Rear Spring - Need six 1965-72 3.75 ea.</p> 
<p>C5TZ-4730-B Rear Axle Bumper - 2 per truck - 4 x 2 - F100/350 1965-72, 2 per truck - 4 x 4 -F100/250, 1965-72, 1965-72 20.00 ea.</p> 	<p>8A-5334-S Rear & Front Clamp Liner -Rubber - Set of six, Front Spring needs 8 pieces for both sides, Rear Spring needs 4 pieces for both sides, Also fits 1963 1956-60 8.00 kit</p> 	<p>59Y-5781-A Main Leaf Bushing -F2, F250, F350 1942-60 11.00 ea.</p> 

MECHANICAL



- Motor |Engine
- Transmission
- Radiator |Grill
- Fuel System
- Generator Starters

MOTOR MOUNTS

Front Motor Support Upper Bracket

<p>C3TZ-6028-A</p> 	<p>8 cylinder 292 -F100-250 (4x2), 8 cylinder 292 -F100-250 (4x4), 8 cylinder 292 -F350-600, 1961-64 25.00 ea.</p>
--	--

Front Motor Mount Upper Insulator (2 Per Truck)

<p>B7C-6038-B 6 cylinder 223 -F100-250, 8 cylinder 292 -F100-700, 1957-60, 6 cylinder 223 -F350-600 Before Ser.#140,001 (1957-61) 1957-60 12.50 ea.</p> 	<p>C3TZ-6038-C 8 cylinder 292 -F500-700 From Ser.#140,001 with power steering & air brakes 1963-64 12.00 ea.</p> 
---	---

Front Motor Mount Lower Insulator (2 Per Truck)

<p>B9TT-6039-A 6 cylinder 223 -F100-250, 8 cylinder 292 -F100-700, 6 cylinder 223 -F350-600 Before Ser.#140,001, (1957-61) 1957-60 10.00 ea.</p> 
--

ORDERS ONLY 1-800-417-3347

Front Motor Mount Lower Insulator (1 Per Truck)

CITT-6A061-C 6 cylinder 223 -F100-250 (4x2),

6 cylinder 223 -F100-250 (4x4), 6 cylinder 223 -F350-600 From Ser.#140,001,
6 cylinder 262 -F600, 8 cylinder 292 -F100-250 (4x2), 8 cylinder 292 -F100-250 (4x4),
8 cylinder 292 -F350-700 Before Ser.#140,001, (1961-63)

1961-64
10.00 ea.



Rear Motor Mount Lower Insulator (2 Per Truck)

CITT-6A061-C 6 cylinder 223 -F100-250 (4x2), 1961-64,

6 cylinder 223 & 262 -F100-250 (4x4), 1963-64,
6 cylinder 223 & 262 -F350, 1963-64,
6 cylinder 223 & 262 -F500-600, 1961-1963,
8 cylinder 292 -F100-250 (4x2), 1961-64,
8 cylinder 292 -F100-250 (4x4), 1961-64,
8 cylinder 292 -F350-700, 1961-64,

1961-64
10.00 ea.



Rear Motor Mount Upper Insulator (2 Per Truck)

TAAA-6068 6 cylinder 223 -
F100-250

Before 1/4/1960,
6 cylinder 223, 262
-F350-600,
8 cylinder 292
-F100-600,
1957-60
19.95 ea.



C3TZ-6068-D 6 cylinder 223 -F100-250 (4x2), 1961-64,

6 cylinder 223 & 262 -F100-250 (4x4), 1963-64,
6 cylinder 223 & 262 -F350, 1963-64,
6 cylinder 223 & 262 -F500-600, 1961-63,
8 cylinder 292 -F100-250 (4x2), 1961-64,
8 cylinder 292 -F100-250 (4x4), 1961-64,
8 cylinder 292 -F350-700, 1961-64,
1961-64
10.00 ea.



C5TZ-6068-A Rear Motor Mount,

4x2 Manual Transmission, 302, 352, 360,
390, V8 -F100, F250,
4x2 Manual Transmission, 240, 300,
6 cyl.-F100, F250
1965-72
15.00 ea.



C0TT-6061-B Rear Motor Mount Lower

w/6 cyl or 8 cyl.
1959-60
7.00 ea.



OVERHAUL GASKET SET

B2A-6008-A Overhaul Gasket Set -

6 cylinder -223

1954-64

115.00 ea.



B6A-6008 Overhaul Gasket Set -

V-8 256, 292

1955-64

80.00 ea.



CYLINDER HEAD GASKET

B6A-6051-B Cylinder Head Gasket Set -

8 cylinder -272, 292

1956-64

10.00 ea.



C3TZ-6051-G Cylinder Head Gasket -

8 cyl.272, 292

1956-64

10.00 ea.



VALVE GRIND GASKET SET

B7AZ-6079-D Valve Grind Gasket Set -

8 cylinder -272, 292

1956-64

30.00 set



OIL PAN GASKET SET

C0AE-6710-A Oil Pan Gasket -

223

1957-64

16.00 ea.



COAZ-6710-B Oil Pan Gasket -

272, 292

1957-64

19.95 ea.



C0AE-6710-C Oil Pan Gasket -

352

1965-66

10.00 ea.



VALVE COVER GASKET SET

B2AZ-6506 Valve Cover Gasket Set -

6 cylinder -215-223

1952-59

14.25 set



B4AZ-6A506 Valve Cover Gasket Set -

8 cylinder, 1 set does 2 valve covers

1954-64

9.95 set



D0AZ-6584-C Valve Cover Gasket -

8 cylinder 330, 352, 360, 361, 390, 391

1964-72

10.00 pr.



352974-S100 Dash to Engine Wiring Clip -holds engine

wiring along the, valve cover and push rod cover -F100/350 1957-72

2.00 ea.



MANIFOLD GASKET SET

B7AZ-9433 Intake Manifold Gasket Set -

8 Cylinder 272, 292

1955-64

14.95 set



B5A-9492-S Exhaust Manifold Gasket Set -

8 cyl.239, 256, 272, 292, 312

1954-64

16.00 set







ORDERS ONLY 1-800-417-3347



PISTONS

<p>B5A-6108-STD <i>Pistons -Standard</i></p>  <p>3.7503 8 cylinder 292 1958-64 100.00 set</p>	<p>B5A-6108-020 <i>Pistons -.020 O/S</i></p>  <p>8 cylinder 292 1958-64 100.00 set</p>	<p>B5A-6108-030 <i>Pistons -.030 O/S</i></p>  <p>8 cylinder 292 1958-64 100.00 set</p>
<p>B5A-6108-040 <i>Pistons -.040 O/S</i></p>  <p>8 cylinder 292 1958-64 100.00 set</p>	<p>B5A-6108-060 <i>Pistons -.060 O/S</i></p>  <p>8 cylinder 292 1958-64 100.00 set</p>	





RINGS

<p>B5AZ-6148-STD <i>Piston Rings - Standard</i></p>  <p>8 cylinder 292 1958-64 40.00 set</p>	<p>B5AZ-6148-020 <i>Piston Rings -.020 O/S</i></p>  <p>8 cylinder 292 1958-64 40.00 set</p>	<p>B5AZ-6148-030 <i>Piston Rings -.030 O/S</i></p>  <p>8 cylinder 292 1958-64 40.00 set</p>
<p>B5AZ-6148-040 <i>Piston Rings -.040 O/S</i></p>  <p>8 cylinder 292 1958-64 40.00 set</p>	<p>B5AZ-6148-060 <i>Piston Rings -.060 O/S</i></p>  <p>8 cylinder 292 1958-64 40.00 set</p>	



CONNECTING ROD & RELATED

<p>CIAZ-6200-C <i>Connecting Rod</i></p>  <p>8 cylinder 352 1965-66 25.00 ea.</p>	<p>EAA-6207 <i>Connecting Rod Bushing</i></p>  <p>6 cylinder 215, 223, 262, 8 cylinder 239, 256, 272, 292, 1954-64 2.50 ea.</p>
---	--

ROD BEARINGS

<p>B5T-6211-STD <i>Rod Bearings -Standard -.06135"-.06185 -</i></p>  <p>8 cyl.239, 256, 272, 292 1954-64 10.95 ea.</p>	<p>B5T-6211-010 <i>Rod Bearings -.010 U/S</i></p>  <p>8 cylinder 239, 256, 272, 292 1954-64 9.95 ea.</p>
<p>B5T-6211-020 <i>Rod Bearings -.020 U/S</i></p>  <p>8 cylinder 239, 256, 272, 292 1954-64 9.95 ea.</p>	<p>B5T-6211-030 <i>Rod Bearings -.030 U/S</i></p>  <p>8 cylinder 239, 256, 272, 292 1954-64 9.95 ea.</p>
<p>B4AE-6211-040 <i>Rod Bearings -.040 U/S</i></p>  <p>8 cylinder 239, 256, 272, 292 1954-64 40.00 set</p>	



CAMSHAFT

<p>B8A-6250-C Camshaft Assembly 8 cylinder 239, Center Journal Grooved 256, 272 1954-64 79.95 ea.</p> 	<p>C4TZ-6250-A Camshaft Assembly 8 cylinder 239, Center Journal Drilled 256, 272 1954-64 79.95 ea.</p> 
---	---

CAMSHAFT RELATED

<p>C3TZ-6A251-A Camshaft Bearing Set -Standard 8 cylinder 239, 256, 272 1954-64 25.00 set</p> 	<p>EAA-6269-A Camshaft Thrust Plate 6 cylinder 215, 223, 8 cylinder 239, 256, 272, 292, 1954-64 10.00 ea.</p> 
--	--

TIMING CHAIN

<p>EAA-6256 Camshaft Gear -Sprocket 6 cylinder 215, 223, 8 cylinder 239, 272, 292, 312, 1954-64 25.00 ea.</p> 	<p>EAA-6268 Timing Chain 6 cylinder 215-223, 8 cylinder 239, 272, 292, 312, 1954-64 25.00 ea.</p> 
--	--

CRANKSHAFT & RELATED





<p>B8A-6306-B Crankshaft Gear 6 cylinder 215-223, 8 cylinder 239, 272, 292, 312, 1954-64, 1952-64 10.00 ea.</p> 	<p>B8A-6306-B-SET Timing Set includes Chain, Cam shaft & Crank shaft Gears 6 cylinder 215-223, 8 cylinder 239, 272, 292, 312, 1954-64, 1952-64 59.95 ea.</p> 
<p>74175-S Crankshaft Gear Woodruff Key For 8BA Engine 8 cylinder 1954-64 .75 ea.</p> 	<p>C3TZ-6312-C Crankshaft Pulley -Double sleeve- F500-600- 8 cylinder 272, 292 1957-64 75.00 ea.</p> 

HARMONIC BALANCER

<p>C3AZ-6312-A Harmonic Balancer - I.D.#C4AE-6316-A or B, 6 19/32 "DIA., 1 19/32 " long for 352, 390, V8 1960-67 120.00 ea.</p> 
--

ORDERS ONLY 1-800-417-3347

MAIN BEARINGS

<p>EBV-6330-STDD Main Bearings -Standard -.0957 -8 cylinder 239, 256, 272, 292 1954-64 98.50 set</p> 	<p>EBV-6330-010 Main Bearings -.010 U/S 8 cylinder 239, 256, 272, 292 1954-64 98.50 set</p> 	<p>EBV-6330-020 Main Bearings -.020 U/S 8 cylinder 239, 256, 272, 292 1954-64 98.50 set</p> 
<p>EBV-6330-030 Main Bearings -.030 U/S 8 cylinder 239, 256, 272, 292 1954-64 98.50 set</p> 	<p>B4AE-6330-040 Main Bearings -.040 U/S 8 cylinder 239, 256, 272, 292 1954-64 98.50 set</p> 	















FLYWHEEL PARTS

<p>EAA-6384 Flywheel Ring Gear -146 Teeth 6 cylinder 215, 223, 262, 1952-64 8 cylinder 239, 256, 272, 292, 1954-64, 1952-64 24.95 ea.</p> 	<p>EAM-6384-A Flywheel Ring Gear -152 Teeth - 279, 317, 302, 332 Engine 1952-57 30.00 ea.</p> 
<p>C4TZ-6384-A Flywheel Ring Gear -188 Teeth 8 cylinder 330, 361, 391 1964-72 40.00 ea.</p> 	<p>C2AZ-6436-A Starter to Flywheel Housing Rubber Seal -8 cylinder 239, 256, 272, 292 1954-64 10.00 ea.</p> 

VALVES & RELATED

<p>B8C-6500 Valve Tappet 6 cylinder 215, 223, 262, - 8 cylinder 239, 256, 272, 292 1952-64 11.95 ea.</p> 	<p>C3SZ-6500-A Valve Tappet - Hydraulic 8 cylinder 352 1965-66 9.00 ea.</p> 	<p>C3AZ-6505-A Exhaust Valve -Length 5.02" -Head Dia.1.52" -Stem Size, STD -Stem Dia.3402 1952-66 10.00 ea.</p> 
<p>C3AZ-6505-C Exhaust Valve -Length 5.02" - Head Dia.1.52" -Stem Size, .015" - Stem Dia..3552 1957-66 10.00 ea.</p> 	<p>C3AZ-6505-D Exhaust Valve -Length 5.02" - Head Dia.1.52" -Stem Size, .030" - Stem Dia..3702, 6 cylinder 215, 223, 1952-64, 8 cylinder 239, 272, 292, 1954-64, 1952-64 10.00 ea.</p> 	

VALVES & RELATED Continued

<p>B7A-6507-AA Intake Valve - Length 5.02" -Head Dia.1.92" -Stem Size STD, - Stem Dia. .3420" 8 cylinder 272, 292 1957-59 10.00 ea.</p> 	<p>COME-6507-N Intake Valve - Length 5.02" -Head Dia.1.65" -Stem Size STD, -Stem Dia..3420", 6 cylinder 215, 1952-53, - 8 cylinder 239, 1954-55, -8 cylinder 292, 1960-64 1952-64 10.00 ea.</p> 	<p>COME-6507-S Intake Valve - Length 5.02" -Head Dia.1.65" -Stem Size .003", -Stem Dia..3450", 6 cylinder 215, 1952-53, - 8 cylinder 239, 1954-55 -8 cylinder 292, 1960-62 1962-62 12.00 ea.</p> 
<p>B6A-6513 Valve Spring 6 cylinder 215, 223, 1952-64 -V-8 239, 272, 292, 312, 1954-64, 1952-64 1.50 ea.</p> 	<p>B8A-6513-C Valve Spring 8 cylinder 352 1965-67 2.00 ea.</p> 	<p>7HA-6518 Valve Keepers 6 cylinder 215, 223, 1952-64 -8 cylinder 239, 256, 272, 292, 1949-64, 1.00 pr.</p> 
<p>C2AZ-6531-B Valve Rocker Arm Shaft Support - 8 cyl. 330, 352, 360, 361, 390, 391 1964-72 12.50 ea.</p> 	<p>B6A-6549-C Rocker Arm Adjusting Screw - 7/16" x 20 x 1.40" Long, 6 cylinder 223, 8 cylinder 272, 292, 1956-64 2.00 ea.</p> 	
<p>B4AZ-6563-A Valve Rocker Arm Shaft - 8 cylinder 239, 256, 272, 292 1954-64 32.50 ea.</p> 	<p>B6A-6564-G Valve Rocker Arm 6 cylinder 1952-64 5.00 ea.</p> 	
<p>EAA-6565-C Valve Push Rod 9-43/64" 6 cylinder 1952-64 4.00 ea.</p> 	<p>C0AE-6565-D Valve Push Rod 8.19" Long - 8 cylinder 272, 292 1956-64 13.95 ea.</p> 	<p>C8AZ-6565-A Valve Push Rod .030 U/S, 8 cylinder 352 1965-71 3.00 ea.</p> 
<p>CITE-6571-C Valve Guide and Valve Stem Seal - 6 cylinder 215, 223, 1952-64 8 cylinder 239, 256, 272, 292, 1954-64, 1952-64 1.00 ea.</p> 	<p>CITE-6571-SET Valve Guide and Valve Stem Seal - (set of 16) 8 cylinder 239,, 256, 272, 292, 1954-64 15.00 set</p>  <p><small>CITE-6571-SET Includes 16 Valve Stem Seals</small></p>	

ORDERS ONLY 1-800-417-3347

VALVES & RELATED Continued

EBU-6575-A Valve Rocker Arm Oil Outlet Tube Bracket -8
 cyl.239, 256,, 272, 292
 1954-64
 3.00 ea.



B5A-6588-A Valve Rocker Arm Shaft Oil Outlet Tube -
 8 cyl.239, 256, 272,, 292
 1954-64
 7.50 ea.



OIL PUMP ASSEMBLIES

C0AE-6600-D Oil Pump Assembly -New -
 V-8 -239, 256
 1955-60
 139.95 ea.



C5AZ-6600-A Oil Pump Assembly
 6 cylinder 240, 300 L/D, 300 H/D
 1965-71
 27.00 ea.



OIL PAN DRAIN PLUG & GASKET

D1AZ-6730-A Oil Pan Drain Plug -1/2" x 20
 6 cylinder 223, 240, 262-300, -
 8 cylinder 272, 292, 302, 330, 352, 360, 361,
 390, 391,
 1958-72
 10.00 ea.



C20Z-6734-A Oil Pan Drain Plug Gasket -
 6 cyl.223, 262, 240, 300, -
 8 cyl.272, 292, 352
 1958-66
 3.00 ea.



OIL PUMP RELATED

C1AE-6A618-A Oil Pump Intermediate Shaft
 8 cyl 292
 1961-64
 6.00 ea.





68-6623 Oil Pump Pick-Up Tube Screen -
 V-8
 1948-64
 14.95 ea.



B4A-6698-A OIL PAN TO PICKUP TUBE SEAL
 Y block, 239, 272, 292, 312
 54-62
 12.50 ea.



OIL FILTERS

<p>B2A-6731-A Oil Filter -  6 & 8 cylinder 1953-66 14.00 ea.</p>	<p>CITZ-6731-D Oil Filter Cartridge-Medium & Heavy Duty  -292 1958-64 6.50 ea.</p>
--	--



OIL FILTER ASSEMBLY

<p>C2AZ-6731-B Special Oil Filter Assembly with check valve so oil won't drain, back Oil light goes out immediately when engine starts  12.50 ea.</p>	<p>D9AZ-6731-A Oil Filter -Motorcraft Spin on type All  0.50 ea.</p>	<p>B7A-6882-A Oil Filter Adaptor Kit -6 & 8 cylinder -Replaces canister to spin-on filter - y-blocks  1952-UP 30.00 ea.</p>
---	--	--

OIL BREATHER CAP

<p>C0AZ-6766-A Oil Filler Cap -Replacement -Black -  6 cylinder 1957-64 5.00 ea.</p>	<p>EAD-6766-B Oil Breather Cap -  8 cylinder 1955-64 10.00 ea.</p>
---	--

OIL PRESSURE SENDING UNITS

<p>B6A-9278 Oil Pressure Sending Unit with Warning Light -12 volt  1954-66 10.00 ea.</p>	<p>C9ZZ-9278-A Oil Pressure Sending Unit Used with Oil Pressure Gauge, F100-750  1964-72 20.00 ea.</p>
---	--

UNIVERSAL JOINTS

<p>21C-7039 Universal Joint -Front & Rear -  1/2 ton 1942-63 20.00 ea.</p>
--

STANDARD TRANSMISSION RELATED PARTS

<p>21C-7052 SEAL, Transmission Tail Shaft,  42-63 Pickup 1942-63 4.95 ea.</p>	<p>BB-7213-A Gear Shift Lever Knob-Black - w/4 spd., transmission  1939-58 4.00 ea.</p>	<p>B6C-7213 Column Gear Shift Knob -Black - Sphere Shape  1956-57 6.95 ea.</p>
---	--	---

ORDERS ONLY 1-800-417-3347

STANDARD TRANSMISSION RELATED PARTS Continued

<p>B8C-7213 Column Gear Shift  Knob - White - Sphere Shape 1958-60 5.00 ea.</p>	<p>C0AZ-7213-B Column Gear Shift  Knob - Black, Recessed End 1961-66 6.00 ea.</p>	<p>357479-S Column Gear Shift  Lever Pin 1956-74 .75 ea.</p>
<p>C0DZ-7228-B Trans Column Shift Gear Shift Socket -  3 speed manual -F100-250 1961-77 110.00 ea.</p>	<p>01A-7246-B Gear Shift Insulator -Rubber  For 3 speed standard 1940-72 9.50 ea.</p>	
<p>B5A-7290-A Transmission Arm Mount  Side of Transmission for Rev and 1st gear F100-250 1957-64 10.00 ea.</p>	<p>AB-7285-B Transmission Arm Mount  Side of Transmission for 2nd and 3rd gear F100-250 1957-64 10.00 ea.</p>	
<p>C5TZ-7303-A Column Shift Lever Arm  for Low and Rev. Gear F100-250 1965-72 20.00 ea.</p>	<p>C5TZ-7302-A Column Shift Lever Arm  for 2nd and 3rd gear F100-250 1965-72 20.00 ea.</p>	
<p>C9TZ-7336-A Column Shift Arm Spacer for  F100-250 1965-72 4.00 ea.</p>	<p>C5TZ-7D363-B Column Gear Shift Arm Thrust Washers,  (2 per truck)-F100/250, Bronco, 1966-77, 1965-79 2.00 ea.</p>	
<p>C3TZ-7343-A Gear Shift Selector  Arm Bushing & Insulator Kit -F100/250 1957-64 4.00 kit</p>	<p>C5TZ-7343-A Gear Shift Selector  Arm Bushing & Insulator Kit -F100/250 1965-72 10.00 kit</p>	<p>A9AZ-7A650-A Overdrive Cable and  Chrome Knob - Cut, to fit -80 1/4" -F100 1957-71 50.00 ea.</p>

AUTOMATIC TRANSMISSION RELATED PARTS

<p>D0TZ-7B097-B Transmission Control Selector Lever Pin for  Neutral Safety Switch -F100, 350 1965-77 22.00 ea.</p>	<p>B9AP-7A098-B Transmission Oil Pan Screen w/Fordomatic,  Cruise-O-Matic, FX trans 1953-64 30.00 ea.</p>	
<p>B6C-7213 Column Gear Shift Knob -Black -Sphere  Shape 1956-60 6.95 ea.</p>	<p>C0AZ-7213-B Column Gear Shift Knob -Black -  Recessed End 1961-66 6.00 ea.</p>	

AUTOMATIC TRANSMISSION RELATED PARTS Continued

<p>C9TZ-7228-A Column Gear Shift Socket - Cruise-O-Matic 1965-72 90.00 ea.</p> 	<p>D3TZ-7A110-A Transmission Gear Shift Socket Indi- cator -use with, C9TZ-7228-A Collar - Original Tooling 1965-72 12.00 ea.</p> 	<p>1M-7246-A Column Gear Shift Lever Insulator -Rubber 1953-66 8.00 ea.</p> 
<p>CIAZ-7A377-B Shift Diaphragm or Modulator for Cruise-O-Matic Trans.-FX, MX, FMX, F100-350 1965-66 45.00 ea.</p> 	<p>C4AZ-7A377-B Shift Diaphragm or Modulator for Automatic Trans- mission -C-4 F100- 250 1965-72 16.50 ea.</p> 	<p>B9C-15805 Column Gear Shift Indicator - Cruise-O-Matic 1959-63 25.00 ea.</p> 

CLUTCH PARTS



<p>C5TZ-7513-A Clutch Fork Boot at Clutch Housing -F100-700 -From Ser.#600,001 1965-72 17.50 ea.</p> 	<p>01A-7517-DC Clutch Release Equal- izer Shaft Bushings -F100-F750 -Need pair 1961-64 5.00 pr.</p> 	<p>D0TZ-7521-C Clutch Release Lever Rod, F100-350 1965-72 16.00 ea.</p> 
<p>B7C-7523-A Clutch Release Spring -F100-600 1957-60 7.50 ea.</p> 	<p>C5TZ-7A535-A Clutch Release Equal- izer Mounting Pivot -6 cyl.240, 300 - F100-350 1965-72 20.00 ea.</p> 	<p>C1AA-7543-A Clutch Release Equal- izer Shaft Ball -White Plastic,.994 "O.D., .631 "I.D., 1/2 "thick -F100/750 -1969-72 E100/300, 1969-72 3.00 ea.</p> 
<p>C5TZ-7A533-A Clutch Rod to Floor Seal -on motor side -premodeled with metal insert, F100-350 1965-67 25.00 ea.</p> 	<p>B8TZ-7A542 Clutch Master cylinder/slave Cylinder 1957- 60 F1 - F6, 1960-67 P100 1957-67 79.95 ea.</p>	
<p>MA-7583-A Clutch & Brake Pedal Arm Bumper F100, F1100 1957-66 2.50 ea.</p> 	<p>81T-7550 11" Clutch Disc - 4-speed 3/4 to 2 ton 1935-64 44.45 ea.</p> 	

ORDERS ONLY 1-800-417-3347



CLUTCH PARTS Continued

<p>29A-7550 10" Clutch Disc w/3 spd Trans 1941-64 44.45 ea.</p> 	<p>19A-7563-N 10" Pressure Plate w/3 spd Trans. 1941-64 108.00 ea.</p> 	<p>51-7563-N 11" Pressure Plate -4-speed 3/4 to 2 ton 1935-64 108.00 ea.</p> 
<p>78-7580 Clutch Release Bearing - F100-600 with 3 & 4 speed transmission 1928-64 23.95 ea.</p> 	<p>B-7600 Clutch Pilot Bearing - F100-600 with 3 & 4 speed transmission 1928-64 5.00 ea.</p> 	

CLUTCH KITS

<p>51-7563-KIT Clutch Kit Includes: 11" New Pressure Plate, Disc, Throwout Bearing & Pilot Bearing. No Core Charges 1935-64 171.45 kit.</p> 	<p>19A-7563-KN Clutch Kit Includes: 10" New Pressure Plate, Disc, Throwout Bearing & Pilot Bearing. No Core Charges 1942-48 170.45 kit.</p> 
--	---

STARTER RING GEAR

<p>1P-7950-E Starter Ring Gear for Ford-O-Matic Transmission, 14.85" O.D. & 146 teeth -6 cylinder F100 1953-62 40.00 ea.</p> 	<p>B5A-7950-A Starter Ring Gear for Ford-O-Matic Transmission, 15.05" O.D. & 148 teeth - 8 cylinder F100 1954-64 45.00 ea.</p> 
---	--

RADIATOR CAP

<p>B7C-8100 Radiator Cap - 7 lbs. pressure 1957-64 6.00 ea.</p> 	<p>C9AZ-8100-A Radiator Cap (replacement)-14 lb. 6 & 8, cyl. 240, 300, 302, 352, 360, 390 1965-72 6.00 ea.</p> 
<p>8A-8115 Radiator Draincock - 1/4" pipe thread with, tubing extension 1948-72 10.00 ea.</p> 	<p>8CM-8115-A Radiator Draincock - 1/4" pipe thread with, right angle outlet 1948-72 5.00 ea.</p> 

RADIATOR PAD KIT

<p>B7C-8125-S Radiator Support to Frame Pad & Bolt Kit 1957-60 15.00 kit</p> 	<p>C1TZ-8125-S Radiator Support to Frame Pad & Bolt Kit 1961-64 30.00 kit</p> 	<p>C4TZ-8125-S Radiator Support to Frame Pad & Bolt Kit 1965-66 60.00 kit</p> 
---	--	--

RADIATOR GRILLE PARTS

C6TZ-8200-B Grille Assembly -Bright Type -will fit 1964 & 1965
 1965
 500.00 ea.



B7C-8312 Radiator Air Deflector to Hood Seal
 1957-60
 10.00 ea.



C2TZ-8316-S Grille Panel Ford Letters -Set of four -FORD
 -F100-750,
 1962-64
 52.50 set



C5TZ-8316-S Grille Panel Ford Letters -Set of four-FORD,
 Originally Licensed Product
 1965-66
 52.50 set



HEATER & RADIATOR HOSE CLAMPS

8A-8287 Radiator Hose Clamp 1-1/4" O.D.
 49-64
 1.25 ea.



AB-8287 Radiator Hose Clamp 1-7/8" O.D.
 52-59
 1.50 ea.



B-8287 Radiator Hose Clamp 2-1/8" O.D.
 2.00 ea.



C0AZ-18572 By-Pass & Heater Clamp
 1960-70
 1.00 ea.



WATER PUMPS-NEW

B6C-8501-D Water Pump -
 6 cylinder -223
 -N.O.S.
 1954-64
 69.95 ea.



D2AZ-8501-AN Water Pump -
 6 cylinder 240, 300
 1965-72
 70.00 ea.



D0AZ-8501-DN Water Pump
 8 cylinder 330 M/D,
 352, 360, 390
 1964-72
 100.00 ea.



THERMOSTATS-DOES NOT INCLUDE GASKET

C2AZ-8575-B Thermostat -
 6 cylinder-160°
 1952-64
 8 cylinder -160°
 1954-67
 8.95 ea.



C2AZ-8575-A Thermostat -
 6 cylinder-160° 1952-
 64 8
 cylinder -160° 1954-
 67
 7.95 ea.



D4PZ-8575-A Thermostat -
 240, 300 6 cyl.,
 352 V8, 192°
 1964-72
 3.00 ea.



THERMOSTAT GASKETS & HOUSING

B5A-8255-A Thermostat Housing Gasket -V-8
 1954-60
 3.00 ea.



EAG-8255-A Thermostat Housing Gasket -6 cylinder
 1952-60
 3.00 ea.



ORDERS ONLY 1-800-417-3347

GAS TANK CAP

01A-18416-A Locking Gas Cap -



Chrome
1951-70
40.00 ea.

8A-9030 Stainless Steel Cap -



Vented
1951-70
9.95 ea.

GAS TANK RELATED PARTS

GTS-9000 Gas Tank Slushing



Compound -
eliminates rust &
seals small, leaks
-sold in quarts
35.00 qt.

GTP-9001 Gas Preservative



& Stabilizer
-prevents gum &
varnish forma-
tion
& corrosion.
Use when car is
not run for long
periods of, time.
25.00 qt.

B7C-9034 Fuel filler neck



1957-60
40.00 ea.

78-9047 Gas Tank Connection



Hose -For Neck
-F100-600
1956-72
12.00 ea.

B-8287 Clamp for



78-9047 hose
-need two -
2 1/8" O.D.
ALL
2.00 ea.

CITZ-9080-A Gas Tank Neck Grommet



1957-66
15.00 ea.

B7C-9284-S Grommet for where gas line goes through



floor pan
1957-60
3.00 ea.

68-9275-F Gas Tank Float -



Brass
1948-60
10.95 ea.

B8C-9275-B Gas Tank Sending Unit -



F100 -F750, -with gasket, & float
1957-60
65.00 ea.

68-9276 Gas Tank Sending Unit to Tank Gasket



-F100-750
1958-60
3.00 ea.

CITZ-9275-12v Gas Tank Sending Unit -





With Gasket & float-F100 -F350
1961-77
52.50.

CITF-9276-B Fuel Tank Unit Gasket -







2 11/16" dia -5 holes 3/16" -
F100, F350 w/in cab tank
1961-77
3.00 ea.

FLEXIBLE FUEL LINES

<p>1A-9288 <i>Flexible Fuel Line -</i> 6 & 8, cylinder 1957-62 9.75 ea.</p> 	<p>B6TZ-9288-A <i>Flexable fuel line under Cab,</i> hooks to tank to frame rail, F100-600 1956-60 12.00 ea.</p> 
--	---

FUEL PUMPS -NEW

<p>C3TZ-9349-B <i>Fuel Pump Repair Kit</i> -F100-700 - 8 cyl.292 - For Carter, pumps stamped-3528 1964 8. 8.00 kit</p> 	<p>6523-9350 <i>Fuel Pump -</i> V-8 1955-60 50.00 ea.</p> 	<p>4208-9350 <i>Fuel Pump -</i> 6 cylinder 1955-60 49.95 ea.</p> 
<p>C4AZ-9365-A <i>Fuel Pump Filter -Used on pumps with filter</i> screwed to bottom, of fuel pump 1964-72 9.00 ea.</p> 	<p>C3AZ-9398-B <i>Fuel Pump Diaphragm -</i> F100-700 -8 cyl.292, 330, 361, 391, For Carter pumps stamped 3528, 3546, 3291-SC, 3710-SA 1963-65 4.00 ea.</p> 	



ELECTRIC FUEL PUMPS

<p>EFP-9350-B <i>Electric Fuel Pump -</i> 12 volt 1956-60 58.95 ea.</p> 
--

CHOKE PLATE SWIVEL



<p>C4TZ-9D563-A <i>Choke Plate Adjustment Swivel</i> w/352 V8 -F100-350 1965-72 5.00 ea.</p> 

ENGINE MANIFOLDS - EXHAUST

<p>B5A-9492-S <i>Exhaust Manifold</i> Gasket Set - 8 cyl.239, 256, 272, 292, 312 1954-64 16.00 set</p> 	<p>IGA-9450 <i>Exhaust Manifold to</i> Exhaust Pipe Gasket -F100-700 - 8cyl.,239,256,272,292, Without heat riser -need one 1954-64 6 cylinder With heat riser -need three, 1948-66 2.50 ea.</p> 	<p>B5A-9450-A <i>Exhaust Manifold</i> to Crossover Pipe Gasket - F100-700 -8 cyl., 239, 256, 272, 292 1955-64 1.25 ea.</p> 
---	--	--

ORDERS ONLY 1-800-417-3347

CARBURETOR REPAIR KITS

<p>59A-9590 <i>Carburetor Repair Kit -V-8 -2 Barrell</i> <i>1937-57</i> <i>23.95 ea.</i></p> 	<p>B2A-9590 <i>Carburetor Repair Kit -6 cylinder - 1 Barrell</i> <i>1952-57</i> <i>39.95 ea.</i></p> 	<p>C20Z-9590 <i>Carburetor Repair Kit -All 2 barrel with Ford Carburetor -V-8</i> <i>1963-66</i> <i>25.00 ea.</i></p> 
---	---	--





AIR CLEANER FILTER

<p>B7A-9601-C <i>Air Cleaner Filter -6 cylinder 223 -F100-500 -7.18" ID x 9.43", OD x 3.47" height, 8 cylinder 272 -F100-350, 1957-1957-60</i> <i>16.50 ea.</i></p> 	<p>C3AZ-9601-B <i>Air Cleaner Filter -8 cylinder 352 -F100-350 - 9 3/4" O.D.x 7, 1/4" I.D.x 2 3/8" height</i> <i>1965-67</i> <i>15.00 ea.</i></p> 	<p>358871-S <i>Air Cleaner Wing Nut</i> <i>2.00 ea.</i></p> 
---	--	---





CLOCK CABLE ASSEMBLY

<p>C5TZ-9700-L <i>Clock Cable Assembly with Bezel for 6 or 8 cyl.(cut to fit), No Knob -F100-350</i> <i>1961-69</i> <i>25.00 ea.</i></p> 
--

AIR CLEANER DECALS

<p>DF-467 <i>Air Cleaner Decal - 223 -139 H.P.</i> <i>1957-60</i> <i>6.50 ea.</i></p> 	<p>DF-470 <i>Air Cleaner Decal - 272 -171 H.P.</i> <i>1957-58</i> <i>6.50 ea.</i></p> 
<p>DF-489 <i>Air Cleaner Decal - 272 -181 H.P.</i> <i>1959-60</i> <i>6.50 ea.</i></p> 	<p>DF-488 <i>Air Cleaner Decal - 292 -172 H.P.</i> <i>1958-60</i> <i>6.50 ea.</i></p> 

ACCELERATOR PEDAL

<p>C0TT-9735-A <i>Accelerator Pedal</i> <i>1957-60</i> <i>19.95 ea.</i></p> 	<p>CITZ-9735-C <i>Accelerator Pedal -Before, Serial #380,001</i> <i>1961-64</i> <i>19.95 ea.</i></p> 
<p>C5AZ-9735-D <i>Accelerator Pedal -From, Ser #696,001 -F100-250</i> <i>1965-66</i> <i>15.00 ea.</i></p> 	<p>C5TZ-9A758-AH <i>Accelerator Cable - 20" long, -F100-250 -8 cylinder 352</i> <i>1965-66</i> <i>57.50 ea.</i></p> 

ELECTRICAL

Ignition Headlights













Parking Lights

Tail Lights

Dome Lights

Horns Wiring Cigar

GENERATOR PARTS

<p>B6A-10002-REB Generator - Rebuilt (exchange \$110.00) \$50 Core Charge 1956-64 245.00 ea.</p> 	<p>B6A-10002-K Generator Rebuild Kit -Includes, 1) CITZ-10005-A Armature, 1) 8BA-10094 Front Bearing, 1) CIAZ-10069-A Brush set, 1) B6A-10095-B Rear Bearing 1957-64 30.00 set</p> 	<p>CITZ-10005-A Generator Armature -30 amp.generator 1956-64 25.00 ea.</p> 
<p>C3AZ-10050-A Generator Rear End Plate and Brush Assembly -30 amp. generator 1956-64 15.00 ea.</p> 	<p>CIAZ-10069-A Generator Brush Set -.90" high x .93" wide x .29" thick 1956-64 4.00 set</p> 	<p>8BA-10094 Generator Front Bear- ing 1940-64 10.00 ea.</p> 
<p>B6A-10095-B Generator Rear Bear- ing 1956-64 12.00 ea.</p> 	<p>C3AZ-10120-A Generator & Starter Bolt -1/4" x 20 x 1" x 6 9/16" long 1948-64 4.00 ea.</p> 	<p>B6A-10139-B Generator Front End Plate 1956-64 7.50 ea.</p> 
<p>CIAZ-10170-B Generator Splash Shield -Rubber 1962-64 20.00 ea.</p> 	<p>C3SZ-10316-B Alternator Regulator - Except Transistorized 1965-66 45.00 ea.</p> 	
<p>C5DZ-10335-A Alternator Rotor Assembly -Fits;Motorcraft Alternators with, these ID numbers: C4TF-10300-AZ-BB-BD-BE-BG-BJ-BL-BM, C5AF-10300-A-B-C-D-E, C5DF-10300-A-B, C5TF-10300-AN, AS-AT-AU-AV, C6AF-10300-A-B-C-D-E, C6DF-10300-A-B, C6TF-10300-A-B-C-D, C7TF-10300-C-D-E, C7ZF-10300-A, C9AF-10300-A, C9ZF-10300-A, D0AF-10300-C-G, D0TF, 10300-C-D, D0ZF-10300-B, D2AF-10300-AA-AB, D20F-10300, DA-DB, D2TF-10300-AA-AB-AC-BA-BB-BC-BD, D2ZF-10300-AA-AB-AC, C5AF-10346-A, C5DF-10346-A-B, C6AF-10346-A-B, C6DF-10346-A, D0AF-10346-E, D2AF-10346-CA-D20F-10336-DA, 1965-72 25.00 ea.</p> 		

ORDERS ONLY 1-800-417-3347

VOLTAGE REGULATOR

C3TZ-10505 Voltage Regulator -Replacement -



12 volts
1956-64
49.95 ea.

BATTERY RELATED PARTS

C4TZ-10732-D Battery Tray Assem-



bly -includes both hold down bolts -4 x 2 F100/250
1961-64
90.00 ea.

CITZ-10A707-A Outer Battery Hold



Down Bolt with special bracket - 4 x 2 F100/250
1961-64
17.50 ea.

C5DZ-10718-B Battery Hold Down



1959-60
10.00 ea.

C0TZ-10756-A Inner Battery Hold



Down Bolt with special washer - 4 x 2 F100/250
1961-64
8.00 ea.

DODZ-10718-A Battery hold down



clamp, F100-250
1965-72
10.00 ea.

DOAZ-10756-A Battery hold down



bolt, F100-250
1965-72
6.00 ea.

BEZEL CLUSTER RELATED PARTS

B9MZ-10804-C Instrument Cluster



Voltage Regulator - Controls Voltage to Gas & Temperature Gauge without printed circuit -F100-1100
1957-66
20.00 ea.

CITF-10852-D Windshield Wiper



Bezel
1961-69
15.00 ea.

CITF-10852-C Instrument Cluster



Light Switch Bezel B, F-N-NT-T100/1100
1961-69
15.00 ea.

ENGINE TEMPERATURE SENDER

B7A-10884-A Engine Temperature Sender -



F100-950, -6 & 8 cylinder
1957-62
20.00 ea.

C3AZ-10884-A Engine Temperature Sender -Stamped,



250 -F100-700 -6 & 8 cylinder
1963
5.00 ea.

C3TZ-10884-A Engine Temperature Sender -Stamped,



230 -F100-700 -6 & 8 cylinder
1963-66
10.00 ea.

B7A-10911-A Water Temperature Sender Adapter -



8, cyl.272, 292
1957-63
15.00 ea.

STARTER ASSEMBLY & RELATED PARTS

B6A-11002-R Starter Assembly -



6 & 12 volt - EXCHANGE ONLY
1954-61
135.00 ea.

C2AZ-11002-K Starter Rebuild Kit -includes, 1)C2AZ-11005-A armature, 1)



A9AZ-11102-B post repair kit, 1)18-11052 rear bushing, 1)ICM-11135-A starter drive bushing, 1)18-11057, brushes
1962-64
30.00 ea.

STARTER ASSEMBLY & RELATED PARTS *Continued*

<p>C2AZ-11005-A Starter Armature  -F100-800 - 6 & 8 cylinder 223, 262, 292, 302, 332 1962-64 25.00 ea.</p>	<p>C2AZ-11130-A Starter Drive End  Plate & Bushing- F100-700- 6 & 8 cyl., 223, 262, 239, 256, 272, 292 1954-64 15.00 ea.</p>	<p>ICM-11135-A Starter Rear End Plate  Bushing -5/8" I.D.x 13/16" O.D.x 1 5/32" long 1954-64 2.00 ea.</p>
<p>C1AZ-11350-A Starter Drive or  Bendix - 6 Cylinder, - V8 1954-61 1952-61 57.50 ea.</p>	<p>C2AZ-11350-C Starter Bendix  -F100-800 - 6 & 8 cylinder 223, 262, 292, 302, 332 1962-64 30.00 ea.</p>	<p>18-11052 Drive End  Bushing 32-62 3.50 ea.</p>
<p>B6A-11450-A Starter Solenoid -  All Models - Replacement 1956-72 12.95 ea.</p>		

IGNITION SWITCHES

<p>B5A-11572 Ignition Switch Hous-  ing, - No Keys, No Cylinder 1956-60 29.95 ea.</p>	<p>C3AZ-11572-A Ignition Switch  Housing, -No Keys, No Cylinder, -Fits all except P-100 -P-500 1961-66 30.00 ea.</p>	<p>BA-11582-A Ignition Cylinder  Assembly & (2)Keys 1953-60 4.50 ea.</p>
<p>C3AZ-11582-A Ignition Cylinder  Assembly & (2)Keys, - Fits all except P-100 -P-500 1961-66 15.00 ea.</p>	<p>BAAA-7022050-S One Ignition Cylin-  der Assembly & Two, Door Lock Cylinders with two keys, all keyed alike 1953-60 50.00 ea.</p>	<p>C3AZ-6222050-B One Ignition  Cylinder Assembly & Two, Door Lock Cylin- ders with two keys, all keyed alike 1961-66 50.00 kit</p>
<p>BA-3685-ANV Anniversary Key  Blank, Ignition only - 1953-66 10.00 ea.</p>	<p>BA-3685-A Ignition Key Blank  - 1953-64 4.50 ea.</p>	<p>C3TZ-11584-A Ignition Switch to Dash  Retainer Bezel, -F- 100-1100 1961-66 20.00 ea.</p>
<p>B7C-11597-A Ignition Switch Mounting Plate -  F100/1100 -goes between Dash Ignition, Bezel & Ignition Switch 1957-60 12.00 ea.</p>	<p>C1TF-10A885-A Ignition Switch Mounting Plate -  goes between dash bezel & ignition switch, -F100-1100 1961-66 10.00 ea.</p>	

ORDERS ONLY 1-800-417-3347

HEADLIGHT SWITCHES - KNOB NOT INCLUDED

<p>C1TF-10852-C Headlight Switch</p>  <p>Dash Bezel - F100-F1100 1961-69 15.00 ea.</p>	<p>B6T-11654-A Headlight Switch</p>  <p>-Universal - 12 volts 1956-57 57.50 ea.</p>	<p>B9AF-11654-A Headlight Switch</p>  <p>-F100-F1100 1958-59 50.00 ea.</p>
<p>C1DF-11654-A Headlight Switch</p>  <p>-F100-F1100 1961 20.00 ea.</p>	<p>C4DZ-11654-A Headlight Switch</p>  <p>-F100-F600 1962-64 47.00 ea.</p>	<p>D3ZZ-11654-A Headlight Switch</p>  <p>-F100-F600 1965-72 65.00 ea.</p>
<p>C2TZ-11650-A Light Switch to Instrument Panel Nut</p>  <p>1955-62 7.00 ea.</p>	<p>C3TZ-11650-A Light Switch Bezel Nut - Screws into light switch - F100-750</p>  <p>1965-72 10.00 ea.</p>	

DASH KNOBS

1957 BLACK

<p>B6C-7213 Column Shift Gear Shift Lever Knob - Sphere Shape</p>  <p>1956-57 6.95 ea.</p>	<p>B7C-9700 Choke, Left Air Vent, and Right Air Vent Knob</p>  <p>1957 6.00 ea.</p>	
<p>B7C-11661 Light switch Knob</p>  <p>1957 9.00 ea.</p>	<p>B4A-13305 Turn Signal Lever Knob</p>  <p>1956-57 6.00 ea.</p>	<p>B7C-15052 Cigar Lighter Knob (Black)</p>  <p>1957 6.00 ea.</p>
<p>B6C-15055 Cigar Lighter Element & Well Assembly</p>  <p>1956-66 15.00 ea.</p>	<p>B7C-17513 Wiper, heater, & radio Knob</p>  <p>2 knobs for radio 1957 7.00 ea</p>	<p>B7C-18817-A Radio Tone Knob -Black - F100-600</p>  <p>1957 5.00 ea.</p>
<p>B7C-8101656 Glove Box Knob</p>  <p>1957 6.00 ea.</p>	<p>B7C-8123345 Window Crank Handle Knob</p>  <p>1957 6.00 ea.</p>	

1958-60 WHITE

<p>B8C-7213 Column Shift Gear Shift Lever Knob - Sphere Shape</p>  <p>1958-60 5.00 ea.</p>	<p>B8C-9700 Choke, Left Air Vent & Right Air Vent Knob</p>  <p>1958-60 6.00 ea.</p>	<p>C2TZ-11650-A Light Switch Bezel Nut - Screws into light switch</p>  <p>1955-64 7.00 ea.</p>
<p>B8C-11661 Light Switch Knob</p>  <p>1958-60 9.00 ea.</p>	<p>B8C-13305 Turn Signal Lever Knob</p>  <p>1958-60 6.00 ea.</p>	

1958-60 WHITE

<p>B8C-15052 Cigar Lighter Knob (White) 1958-60 6.00 ea.</p> 	<p>B6C-15055 Cigar Lighter Element & Well Assembly 1956-66 15.00 ea.</p> 	<p>B8C-18817-A Radio Tone Knob -White -F100-600 1958-60 5.00 ea.</p> 
<p>B8C-17513 Wiper, Heater & Radio Knob - 2 knobs for radio 1958-60 6.00 ea.</p> 	<p>B8C-8101656 Glove Box Knob 1958-60 6.00 ea.</p> 	<p>B8C-8123345 Window Crank Handle Knob 1958-60 6.00 ea.</p> 

1961-66 BLACK WITH WHITE INSERT

<p>C0AZ-7213-B Column Shift Gear Shift Lever Knob -Black 1961-66 6.00 ea.</p> 	<p>CITZ-9700 Choke, Air Vent & Heater Temperature Knob 1961-66 6.00 ea.</p> 	<p>C2TZ-11650-A Light Switch Bezel Nut -Screws into light switch 1955-64 7.00 ea.</p> 
<p>C3TZ-11650-A Light Switch Bezel Nut -Screws into light switch 1965-66 10.00 ea.</p> 	<p>CITZ-11661 Light Switch Knob with Shaft - 2.5" long 1961-66 10.00 ea.</p> 	<p>CITZ-11661-L Light Switch Knob with Shaft - 3.5" long 1961-66 10.00 ea.</p> 
<p>C0AZ-13305-B Turn Signal Lever Knob -Black 1961-66 6.00 ea.</p> 	<p>CITZ-15052 Cigar Lighter Knob 1961-66 8.00 ea.</p> 	<p>B6C-15055 Cigar Lighter Element & Well Assembly 1956-66 15.00 ea.</p> 
<p>CITZ-17513 Wiper, Heater Fan & Emergency Warning Flasher Knob 1961-66 10.00 ea.</p> 	<p>CITZ-8101656 Glove Box Knob 1961-66 6.00 ea.</p> 	<p>CITZ-8123345 Window Crank Handle Knob -Black 1961-66 6.00 ea.</p> 





















ELECTRONIC IGNITION SYSTEM

REPLACES POINTS & CONDENSER IN DISTRIBUTOR

<p>B7A-12000-1281 Solid State Electronic Ignition System, - 8 cyl.all except dual point distributor 1957-74 90.00 ea.</p> 
--

ORDERS ONLY 1-800-417-3347

IGNITION

<p>7RA-12171-KIT Ignition Tune-Up Kit -6 cylinder -Includes points, condenser, and rotor 1948-64 12.95 set</p> 	<p>B8Q-12171-SET Ignition Tune-Up All V8, Includes points, condenser, and rotor 1957-64 12.95 set</p> 	<p>B6A-12029 Coil -12 volts - Fits All except transistorized ignition systems 1956-72 19.95 ea.</p> 
<p>7HA-12106 Distributor Cap - 6 cylinder 1948-60 9.95 ea.</p> 	<p>B7A-12106 Distributor Cap - 8 cylinder 1957-72 11.95 ea.</p> 	<p>7RA-12144 Distributor to Cap Hold Down Clamp -6 & 8 cylinder, - 2 per distributor 1949-66 4.00 ea.</p> 
<p>B-12145 Distributor Cap Clip Rivet -takes two 1960-64 1.00 ea.</p> 	<p>FAA-12171-A Points - 6 cylinder 1948-63 4.00 ea.</p> 	<p>B8Q-12171 Points - 8 cylinder 1957-72 4.45 ea.</p> 
<p>59A-12200 ROTOR,for 59A- 12105/6 two piece cap also fits FAB-12106 cap; also fits 49-60 6 cylinder, 45-56 V8 1945-60 5.50 ea.</p> 	<p>B7A-12200 Rotor - 8 cylinder 1957-72 3.95 ea.</p> 	<p>C5TZ-12216-A Primary Distributor Lead Wire for V8 -19" long 1957-67 5.00 ea.</p> 
<p>C0DF-12216-A Distributor Primary Lead - 6 & 8 cylinder 1948-60 13.00 ea.</p> 	<p>B6A-12250-C Ignition Coil Resistor -6 & 8 cylinder 1956-57 18.00 ea.</p> 	<p>C0DF-12250 Ignition Coil Resistor -6 & 8 cylinder 1960 35.00 ea.</p> 
<p>7RA-12264 Distributor Ground Lead -6 cylinder 1948-64 3.00 ea.</p> 	<p>FAB-12300-A Condenser - 6 cylinder 1948-64 6.00 ea.</p> 	<p>B7A-12300 Condenser - 8 cylinder 1957-72 2.95 ea.</p> 
<p>7RA-12370 Distributor Vacuum Advance - 6 cylinder 1947-60 24.95 ea.</p> 	<p>B9AF-12370-A Distributor Vacuum Diaphragm - 8 cyl.-Fits;Distributors with these, ID numbers, B7AF-12127-A, B9TF-12127-B, C0TF-12127-B, C3TF-12127-A-K, C4TF-12127-E-F 1957-64 36.00 ea.</p> 	

IGNITION *Continued*

C5AZ-12370-A *Distributor Vacuum Diaphragm -8 cyl.Fits; Distributors with these, ID numbers - C5AF-12127-A-B-AU, C5TF-12127-A, C5TF-1217-A-B-C-AB-AD, C6TF-12127-G-H-AA-AB-BJ, C70F-12127-AA-B, C7TF-12127-A-D-F-M, C7ZF-12127-F, C8TF-12127-H-L, C9UF-12127-C-D, D0TF-12127-G-K, D1TF-12127-EA, D1UF-12127-AA, 1957-66*
 36.00 ea.



FAE-12390-A *Distributor Driven Gear - 14 teeth for V-8 1957-64*
 5.00 ea.



SPARK PLUGS & WIRES

B5A-12259 *Spark Plug Wire Set with Weatherproof Ends -Original -V-8, 239, 272, 292, 312 1954-64*
 87.69 set



D1AZ-12259-F *Spark Plug Wires -V-8 -272, 292, 312 - graphic core 1954-64*
 57.50 set



C5AZ-12259-F *Spark Plug Wires -V-8 -352, 360, 390 - graphic core 1965-71*
 60.00 set



FAA-12111-2K *Spark Plug Wire Mounting Brackets - 239, 272, 292, 312 1954-64*
 25.00 kit



FAA-12297-K *Spark Plug Wire Mounting Grommets -Rubber -Set of 4 pcs.-239, 272, 292, 312 1954-64*
 20.00 kit



B5A-12299-A *Spark Plug Metal Shield -Need 4 per truck -V-8 239, 272, 292, 312 1954-64*
 6.00 ea.



B5C-12405-A *Spark Plug - 18MM 1955-66*
 3.50 ea.



B7A-12405-A *Motorcraft Spark Plug BSF6 w/6 cyl.and 8 cyl. 1955-61*
 2.50 ea.



B8A-12405-A *Spark Plug 332/352 V-8 s 1958-70*
 2.75 ea.



HEADLIGHT PARTS

B8AZ-13007-A *Headlight Bulb -#4000 -Outer Low Beam -12 volt 1958-60*
 10.00 ea.



B8AZ-13007-B *Headlight Bulb -#4001 -Inner High Beam - 12 volt 1958-60*
 10.00 ea.



B6A-13007 *Headlight Bulb -#6014 -12 volt Also fits - 1956-57 1961-66*
 8.00 ea.



C4AZ-13031-A *Headlight Bucket Spring 1965-66*
 2.00 ea.



C20Z-13031-A *Headlight Adjusting Ring Retainer Spring -from ser #190,001, to #623,001 1961-65*
 2.00 ea.













01A-13018-C *Headlight Bulb Retainer Ring -Stainless 1940-66*
 17.00 ea.



ORDERS ONLY 1-800-417-3347



HEADLIGHT PARTS Continued

<p>CITZ-13064-C Headlight Door Chrome Plated Steel -Right Side -F100-F700, - Original Tooling 1961-66 85.00 ea.</p> 	<p>CITF-13064-C Headlight Door Chrome Plated Steel -Left Side -F100-F700, - Original Tooling 1961-66 85.00 ea.</p> 	<p>CITZ-13064-D Headlight Door Plain Steel -Right Side -F100-700, - Original Tooling 1961-66 40.00 ea.</p> 
<p>CITF-13064-D Headlight Door Plain Steel -Left Side -F100-700, - Original Tooling 1961-66 40.00 ea.</p> 	<p>CITZ-13064-AL Headlight Door Aluminum - Right Side - F100-700, - Original Tooling 1961-66 85.00 ea.</p> 	<p>CITF-13064-AL Headlight Door Aluminum - Left Side - F100-700 - Original, Tooling 1961-66 85.00 ea.</p> 
<p>B9AF-13076-A Headlight Bulb Wire -Fits RH or LH -F100-350 1960 35.00 ea.</p> 	<p>B9TF-13076-A Headlight Bulb Wire -RH 71" long -F100-350 1958-59 34.00 ea.</p> 	<p>B9TF-13105-A Headlight Bulb Wire -LH 20" long -F100-350 1958-59 24.00 ea.</p> 
<p>C1DZ-13118-A Headlight Bulb Retainer Bucket - Right or Left F100-750 1957 20.00 ea.</p> 	<p>C2TZ-13181-A Headlight Adjusting Nut F-B 100/750, 1962-66 N-NT 500/1100, 1963-69 1.00 ea.</p> 	

PARK LIGHT ASSEMBLY

<p>C0TF-13200-K Park Light Assembly -Right, side -w/turn signal -F100, 600 -w/clear lens 1959-60 37.50 ea.</p> 	<p>C0TF-13201-K Park Light Assembly -Left, side -w/turn signal -F100, 600 -w/clear lens 1959-60 37.50 ea.</p> 
<p>C2TZ-13200-D Park Light Assembly -Right, or Left side -w/turn signal, F100-1100 -w/clear lens 1961-64 37.50 ea.</p> 	<p>C3TZ-13200-E Park Light Assembly -Right, or Left Side -w/turn signal, F100-1100 -w/amber lens 1961-64 37.50 ea.</p> 

PARK LIGHT PARTS

<p>B7C-13208-A Park Light Lens -Clear 1957-58 7.50 ea.</p> 	<p>B7C-13208-AMB Park Light Lens -Amber 1957-58 7.00 ea.</p> 	<p>B9C-13208-A Park Light Lens -Rectangular -Clear 1959-64 7.00 ea.</p> 
--	---	--





PARK LIGHT PARTS *Continued*

<p>DIUZ-13208-A Park Light Lens -Rectangular -Amber 1959-64 7.00 ea.</p> 	<p>C5TZ-13208-A Park Light Lens -Rectangular -Amber - F100-F750 1965-66 7.00 ea.</p> 	<p>B7C-13211-A Park Light Lens Gasket - Round 1957-58 8.00 pr.</p> 
<p>B9C-13211-B Park Light Lens Gasket - Rectangular 1959-64 5.00 pr.</p> 	<p>C5TZ-13211-A Park Light Lens Gasket - Rectangular 1965-66 6.00 pr.</p> 	<p>B7C-13217-A Park Light Housing to Fender Gasket 1957-58 8.00 pr.</p> 
<p>C5TZ-13210-A Park Light Door -Aluminum - Right Side - F100-F750, - Original Tooling 1965-66 50.00 ea.</p> 	<p>C5TZ-13212-A Park Light Door -Aluminum - Left Side - F100-F750, - Original Tooling 1965-66 50.00 ea.</p> 	

TURN SIGNAL RELATED PARTS

<p>FAA-13318-A Turn Signal Turn Off Cam, on Steering Wheel 1957-60 10.00 ea.</p> 	<p>B6C-13341-A Turn Signal Switch -F100-600 1956-60 80.00 ea.</p> 	<p>C0DZ-13341-A Turn Signal Switch Wiring, (W/O mounting plate), F100-350 1961-62 40.00 ea.</p> 
<p>C9TZ-13341-C Turn Signal Switch -F100 1965-69 32.95 ea.</p> 	<p>C1TF-13377-AP Turn Signal Switch Wire, to Steering Column Clip, need 2 per pickup 1957-62 4.00 ea.</p> 	

TAIL LIGHTS -FORD SHIELD TYPE -FOR STEP SIDE, BED

<p>B6C-13404-RT Tail light Assembly - Right Side - Painted 1955-Up 30.00 ea.</p> 	<p>B6C-13404-SS Tail light Assembly - Right Side - Stainless 1955-Up 40.00 ea.</p> 
<p>B6C-13405-LR Tail light Assembly - Left Side - Painted 1955-Up 30.00 ea.</p> 	<p>B6C-13405-SS Tail light Assembly - Left Side - Stainless 1955-Up 40.00 ea.</p> 

ORDERS ONLY 1-800-417-3347

TAIL LIGHT WITH BACK UP LIGHT -FOR ALL EXCEPT STYLE SIDE

C7TZ-13450-C Tail light Lens for
B7C Tail lights with Back-Up Lights
20.00 ea.



LICENSE PLATE BRACKET -ALL EXCEPT PANEL & STYLE SIDE

B-13406-A License Plate Bracket -
Rear -Painted Black
1948-Up
10.00 ea.



B-13406-SS License Plate Bracket -
Polished Stainless
1948-Up
24.50 ea.



TAIL LIGHT RELATED PARTS

B7C-13211-A Tail light Lens to
Housing Gasket,
-Style-Side Only
1957-63
8.00 pr.



B7C-13217-A Tail light Lens to
Body Gasket, Style-
Side Bed
1957-63
8.00 pr.



B6C-13410-A Tail light Wire for Step
Side Bed, -F100-350
1953-72
20.00 ea.



BD-13450-S Blue Dot (glass)with
Chrome, Retainer
to Install in old
Lens
1957-1966
7.00 ea.



B5C-13450-A Tail light Lens -Shield
Type, -Plastic -with
FoMoCo Script,
-Original Tooling
1955-Up
14.95 ea.



B5C-13450-FS Tail light Lens -Shield
Type,
Ford Script
-Chrome Plated
1955-Up
15.95 ea.



B5C-13450-BL Tail light Lens -
FORD molded,
into lens -Plastic
Shield Type, -
1955-Up
15.95 ea.



B5C-13450-SBD Tail light Lens -
Ford Script with,
Blue Dot -
Chrome Plated
1955-Up
29.95 ea.



B5C-13450-FBD Tail light Lens -
FORD molded, into
lens -Plastic
Blue Dot,-
1955-Up
24.95 ea.



B5C-13450-PBD Tail light Lens -
Plain with
Blue, Dot installed
-Shield Type
1955-Up
25.00 ea.



B7C-13450 Tail light Lens -
Plain -Round, Type
-Style-Side Only
-Fender Inside Bed
1957-64
7.00 ea.



B7C-13450-B Tail light Lens for Pan-
el Truck, Mounted
on door
1957-60
10.00 ea.



B9C-13450-A Tail light Lens
-Round Type,
-Plastic -With
FoMoCo Script,
-Original Tooling
1953-Up
7.00 ea.













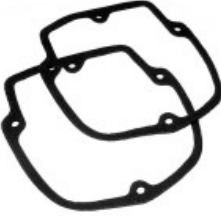

C1TB-13450-B Tail light Lens -Rect-
angular, Uni-Body
-
F100-250
1961-63
20.00 ea.





C4TZ-13450-D Tail light Lens -
Plain, Rectangular
-Right Side-Style,
Side Only-Fender
Inside Bed
1964-66
15.00 ea.





TAIL LIGHT RELATED PARTS Continued

<p>C4TZ-13451-D Tail light Lens -Plain, Rectangular -Left Side - Style, Side Only- Fender inside Bed 1964-66 15.00 ea.</p> 	<p>B5C-13461 Lens to Housing Gas- ket - Shield, Type 1955-Up 6.00 pr.</p> 	<p>C1TF-13461-A Tail light Lens to Housing Gasket, -Uni-Body - F100-250 1961-63 8.00 pr.</p> 
<p>C4TZ-13461-A Tail light Lens to Housing Gasket, -Style-Side Bed 1964-66 8.00 pr.</p> 	<p>C4TZ-13489-E Tail light Door - Right Side, Original Tooling -Anodized, Aluminum 1964-66 35.00 ea.</p> 	<p>C4TZ-13489-F Tail light Door - Left Side, Original Tooling -Anodized, Aluminum 1964-66 35.00 ea.</p> 
<p>B7C-13550-A License Plate Light Assembly, for Style Side Bed -F100-250, 1957 30.00 ea.</p> 	<p>D0TZ-13550-R License Plate Light Assembly, Replacement in bumper -F100-350 1964-73 12.50 ea.</p> 	<p>B5C-13564-B License Plate Light Lens - Shield Type 1955-Up 4.00 ea.</p> 
<p>C1TB-13564-A License Plate Light Lens, glass 1957-63 10.00 ea.</p> 	<p>FAA-13568-A License Plate Light Lens Gasket 1957-63 2.00 ea.</p> 	<p>B5C-13447 License Plate Light Lens Gasket, -Shield Type 1955-Up 3.00 ea.</p> 
<p>C9TZ-13550-A License Plate Light Assembly, for Style Side Bed -F100-250, - 1964-72 47.50 ea.</p> 	<p>B-13578 Tail light Wiring Conduit, Universal -Stainless -Covers, wire from Tail light to bed -24", long -Step Side Only All 15.00 pr.</p> 	

BRAKE LIGHT SWITCHES

<p>11A-13480 Brake Light Switch 1940-66 6.95 ea.</p> 	<p>01A-13480 Brake Light Switch USA Echlin female ends 1959-66 6.95 ea.</p> 	<p>B6A-13644-R 90 DEG FEMALE PIG TAIL used w/ 11A-13480 stop lt switch 28-70 6.50 ea</p> 
---	--	---

HEADLIGHT DIMMER SWITCH

<p>B9A-13532-A Headlight Dimmer Switch 1960-72 11.00 ea.</p> 	<p>B7A-13532 Headlight Dimmer Switch 1957-59 35.00 ea.</p> 
---	--

ORDERS ONLY 1-800-417-3347

DOME LIGHT PARTS

<p>FDA-13783-A Dome Light Lens -F100-F600 1957-58 8.25 ea.</p> 	<p>B8S-13783-B Dome Light Lens -F100-F600 1959-60 7.50 ea.</p> 	<p>CITZ-13783 Dome Light Lens -F100-F600 1961-63 8.50 ea.</p> 
<p>CITZ-13788-C Dome Light Lens Bezel -Plastic, Chrome Plated F100-F1100 1961-63 20.00 ea.</p> 	<p>C0TF-13A706-A Dome Light Lens Gasket 1959-60 15.00 ea.</p> 	
<p>C0TF-13787-A Dome Light Lens Bezel -Plastic, Chrome Plated 1959-60 20.00 ea.</p> 	<p>C4TZ-13783-CC Dome Light Lens - F100-F1100, Chrome Bezel 1964-69 20.00 ea.</p> 	

HORN BUTTON OR RING INDEX PLATE

<p>C0DZ-13A805-A Horn Ring -Chrome -Deluxe Cab -F100/350 - Mfg. USA 1961-70 82.50 ea.</p> 	<p>C3TZ-3649-B Steering Wheel Hub Emblem -"Ford" Plastic 4x2 -F100-250 1961-67 30.00 ea.</p> 	<p>C3TZ-13A805-C Horn Button Assembly -F100-250 STD Cab, - Original Tooling 1961-70 35.00 ea.</p> 
<p>C0DZ-13A807-B Horn Button Spring -used with horn button or ring -F100-250 1961-72 3.00 ea.</p> 	<p>C2DZ-13A809-A Horn Button Index(Retainer)- Except 4-wheel drive -F100-F350 1961-66 6.00 ea.</p> 	<p>C0DZ-13A813-A Horn Ring Pressure Pad in Rubber Under Ring Above Horn, Index Plate, -Original Tooling 1961-70 12.00 ea.</p> 
<p>A7TZ-13A807-A HORN BUTTON SPRING used with horn blowing button. 57-60 F-100-1100 7.95 ea</p> 	<p>FAB-14308-A/WP Horn Button Wire 1948-60 11.64 ea.</p> 	<p>COAF-13A821-A Horn Blowing Ring Contact Brush Assembly -F350-1100 1961-66 8.50 ea.</p> 
<p>C20Z-13A821-A Horn Blowing Ring Contact Brush Assembly -F100-F250 1961-72 6.50 ea.</p> 	<p>7RC-14479 Horn Button Index Spring 1948-60 3.95 ea.</p> 	

HORN RELAY

<p>B8C-13853 Horn Relay and Bracket 1957-66 9.95 ea.</p> 	<p>C4AZ-13853-A Horn Relay and Bracket 1965-72 17.50 ea.</p> 
---	--

WIRING

<p>B7C-14401-A Cowl Wiring - 6 & 8 cylinder, F100 1957-27 468.00 ea.</p> 	<p>B8C-14401-A Cowl Wiring - 6 & 8 cylinder, F100 1958-59 468.00 ea.</p> 	<p>B7C-14289-A Dash Panel to Engine Gauge Feed, Wire for 272, 292, V8 -F100-350, only 1957-64 39.78 ea.</p> 
<p>B7C-14405-A Tail light Wiring - No Turn Signals 1957-59 70.20 ea.</p> 	<p>B7C-14405-D Tail light Wiring w/Turn Signal, F100-350 1957-59 66.11 ea.</p> 	<p>B6A-14305-D Gen to Voltage Regula- tor Wiring, Harness for 223 6 cyl. 1957-60 40.95 ea.</p> 
<p>B9AF-14526-A Electrical Circuit Breaker-12 Amp- All, with marker & clearance lamps 1958-64 17.50 ea.</p> 	<p>B-14487 Wiring Connector .60 ea.</p> 	<p>59A-14487 Double Splice or Four-Way Wiring Connector 2.25 ea.</p> 
<p>8A-14608 Cowl Wiring Grommet Retainer, F100-1100, -Original Tooling 1957-66 10.00 ea.</p> 	<p>18-14605 Firewall Grommet for Choke or Wiper 1957-63 1.00 ea.</p> 	



EMERGENCY FLASHER BEZEL

<p>C5TZ-15C580-A Emergency Flasher to Dash Bezel 1965-66 25.00 ea.</p> 

BODY

- Fenders
- Running Board
- Hood
- Speedometer
- Mirrors Wipers Bumpers Shocks

AUTOMATIC TRANSMISSION GEAR SHIFT INDICATOR DIAL

<p>BAAA-15805 Automatic Transmission Gear Shift Indicator Dial Ford-O-Matic, Clear -Plastic with silver letters 1959-63 15.00 ea.</p> 	<p>B9C-15805 Automatic Transmission Gear Shift Indicator Dial Cruise-O-Matic, Clear -Plastic with red letters 1959-63 25.00 ea.</p> 
--	---

ORDERS ONLY 1-800-417-3347

FENDER WELT

B-16070 Fender Welt -25' roll -Quality,
Black Vinyl with Black Bead
All
17.50 ea.



COWL TO FENDER SEALS

B7C-16120 Top Back of Front Fender to Cab Seal
1957-60
6.00 pr.



B6C-16126-A Front Fender to Cowl Seal -
between fender and cab
1957-60
5.00 pr.



B7C-16246-PR Front Fender Rear to Body Pillar Seal
1957-60
15.00 pr.



CITB-16246-PR Front Fender Rear to Body Pillar Seal
-F100-1100 -23 1/2"
1961-66
15.00 pr.



REAR FENDERS

BAAA-16312-A Rear Fender -Right -Step-Side Only -F100-
F350, -
Original 16 Gauge Steel, -Original Tooling
-SHIPPED BY MOTOR FREIGHT
1953-72
350.00 ea.



BAAA-16313-A Rear Fender -Left -Step-Side Only
-F100-F350, -Original 16 Gauge Steel,
Original Tooling -SHIPPED BY MOTOR
FREIGHT
1953-72
350.00 ea.



355471-S8 Special bolt to fasten rear fenders
to bed side,
Exactly as original-5/16" x 24 x 5/8
1948-72
1.00 ea.



355471-SET Special bolt to fasten rear fenders to bed
side, Exactly as original-5/16" x 24 x 5/8
-Set Of 24
1948-72
20.00 set



FORD SCRIPTS

91A-16606 Ford Script _ Chrome Plated with,
installation clips 3" x 1"
1939-40
25.00 ea



01A-16606-C Ford Script - Chrome Plated with,
installation clips -2-1/2" x 3/4
1940-40
24.00 ea



HOOD PARTS

C1TZ-16607-A Hood Front Emblem -
With V-8,
-F100-1100 -w/Clips,
1965-66
60.00 ea.



C1TZ-16607-B Hood Front Emblem-
5 stars with, gear & lighting -F100-1100,
Original Tooling -w/Clips
1961-66
55.00 ea.



C1TZ-16638 Hood Emblem Pad
1961-66
6.00 ea.



C3TZ-16700-F Hood Lock -
F100-700
1961-66
75.00 ea.



C3TZ-16719 100 Plastic Insert
for Side of Hood
Emblem
1963-64
30.00 pr



HOOD PARTS Continued		
<p>C3TZ-16719-250 250-Plastic Insert for Side of Hood Emblem  1963-64 30.00 pr.</p>	<p>C3TZ-16719-350 350-Plastic Insert for Side of Hood Emblem  1963-64 30.00 pr.</p>	<p>C3TZ-16719-500 500-Plastic Insert for Side of Hood Emblem  1963-64 30.00 pr.</p>
<p>C3TZ-16719-600 600-Plastic Insert for Side of Hood Emblem  1963-64 30.00 pr.</p>	<p>C3TZ-16719-700 700-Plastic Insert for Side of Hood Emblem  1963-64 30.00 pr.</p>	<p>C5TZ-16719-B Twin I Beam Plastic Insert for Side of Hood  1965-66 26.00 pr.</p>
<p>C3TZ-16720-C Hood Side Nameplate -FORD, 100 -F100 -w/Clips, - 1963-64 will fit F100 without moldings, 1965-66 1963-66 84.95 ea</p> 	<p>C3TZ-16720-D Hood Side Nameplate -FORD, 250 -F250 -w/Clips, 1963-64 will fit F250 without moldings, 1965, 1963-65 84.95 ea.</p> 	<p>C3TZ-16720-E Hood Side Nameplate -FORD, 350 -F350 -w/Clips, 1963-64 will fit F350 without moldings, 1965-66, 1963-66 84.95 ea.</p> 
<p>C3TZ-16720-F Hood Side Nameplate -FORD, 500 -F500 -w/Clips, 1963-66 84.95 ea.</p> 	<p>C3TZ-16720-G Hood Side Nameplate -FORD, 600 -F600 -w/Clips, 1963-66 84.95 ea.</p> 	<p>C3TZ-16720-H Hood Side Nameplate -FORD, 700 -w/Clips, 1963-64 84.95 ea.</p> 
<p>C6TZ-16720-B Fender Side Nameplate F100, Twin I Beam - Except Camper, Special -Original Tooling, w/clips 1966-60 60.00 ea.</p> 	<p>B7C-16740 Cowl Lacing Kit - w/Clips 1957-60 10.00 ea.</p> 	<p>C1TZ-16740-B Cowl Lacing Kit -F100-F1100, -w/Clips 1961-66 10.00 ea.</p> 
<p>B7C-16761 Hood Bumper Kit - 6 pcs. 1957 10.00 kit</p> 	<p>B8C-16761 Hood Bumper Kit - All 1965 before Serial #600-001 6pc 1958-65 12.00 kit</p> 	<p>C5TZ-16761 Hood Bumper Kit -Set of 3 -All, 1965 from Serial #600,001 1965-66 12.00 set</p> 
<p>C1TZ-16789-A Hood Hinge Spring - F100-700 1961-66 20.00 ea.</p> 	<p>C2TZ-16796-C Hood Hinge -Right Side - F100, 1100 -Import -Spring Included 1961-66 100.00 ea.</p> 	

ORDERS ONLY 1-800-417-3347

HOOD PARTS Continued

C2TZ-16797-C Hood Hinge -Left Side -
F100, 1100 -Import -Spring Included
 1961-66
 100.00 ea.



CITZ-16900-D Hood Latch -
F100-700
 1961-66
 5.00 ea.



SPEEDOMETER CABLE & HOUSING PARTS

NOTE: Before ordering speedometer cable, check the end of the cable where it goes into the transmission to be sure to order the correct part. See diagram & also make sure the speedometer head turns freely.



Speedometer Cable
 A9A-17260-A

48-17265 Speedometer Cable Grommet
 1957-60
 3.00 ea.



A9A-17260 Speedometer Cable & Housing Assembly -
3 speed,,
Automatic & Over-
drive -70.25
 1953-60
 16.00 ea.



B7C-17260-A Speedometer Cable & Housing Assembly -
w/4 spd.-69.2
 1957-60
 20.00 ea.



C3TZ-17260-ED Speedometer Cable & Housing Assembly
-Three speed transmission
-F100 -59"
 1961-63
 25.00 ea.



C5TZ-17260-Y Speedometer Cable & Housing -
72.50"
3-Speed Light & Medium Duty
Transmission - 4 x 2,
4-Speed Warner Transmission -4 x 2
 1965-66
 20.00 ea.



B7C-17310-S Instrument Panel Assembly to Dash Seal
 1957-60
 5.00 ea.



CITZ-17310-A Instrument Panel Assembly to Dash Seal
-ALL Except Custom Cab
- Fits metal dash only
 1961-66
 5.00 ea.



REAR VIEW MIRROR ASSEMBLY

B6C-17700-B Inside Rear View Mirror
-Chrome -unibody
 1961-63
 50.00 ea.



BAAA-17696-H Mirror Head
Only -fits BAAA, B6C-17696-S Mirror -
F100-350
 1953-66
 25.00 ea.



REAR VIEW MIRROR ASSEMBLY Continued







<p>B6C-17696-S <i>Outside Rear View Mirror Assembly</i> complete with all attaching, parts -Ford Script, Mfg. in USA, Original Tooling 1956-66 65.00 ea.</p>  	<p>BAAA-17699-S <i>Mirror Arm to Door Grommet</i> 1953-66 3.50 ea.</p> 
<p>B6C-17727-A <i>Mirror Arm in Door</i> 1956-66 15.00 ea.</p> 	<p>352488-S <i>Plug to Fill Door Mirror Bracket hole -</i> to be used when you do not have a mirror 1953-66 3.00 ea.</p> 

SPEEDOMETER CABLE & DRIVE GEAR

3 SPEED, AUTOMATIC TRANSMISSION

<p>C0DZ-17271-A <i>Speedometer Gear</i> 16 teeth - Burgundy 1963 -UP 10.00 ea.</p> 	<p>C3DZ-17271-C <i>Speedometer Gear 17</i> teeth -White 1963 -UP 10.00 ea.</p> 	<p>C0DD-17271-B <i>Speedometer Gear 18</i> teeth -Yellow 1963 -UP 10.00 ea.</p> 
<p>C1DZ-17271-A <i>Speedometer Gear</i> 20 teeth - Black 1963 -UP 10.00 ea.</p> 	<p>C40Z-17271-A <i>Speedometer Gear</i> 21 teeth - Red 1963 -UP 10.00 ea.</p> 	

4 SPEED TRANSMISSION

<p>C2DZ-17271-J <i>Speedometer Gear 16</i> teeth w/Orange 1963 -UP 10.00 ea.</p> 	<p>C4DZ-17271-A <i>Speedometer Gear 19</i> teeth w/Pink 1963 -UP 10.00 ea.</p> 	<p>E0TZ-17271-A <i>Speedometer Gear 21</i> teeth w/Red 1963 -UP 10.00 ea.</p> 
<p>C1DZ-17292-A <i>Speedometer Drive Gear Retainer Clip</i> 1933-66 2.00 ea.</p> 	<p>B5A-17322-A <i>Speedometer Gear</i> 20 teeth w/Blue 1955-62 13.95 ea.</p> 	
<p>B5A-17322-B <i>Speedometer Gear</i> 21 teeth w/Green 1961-62 15.00 ea.</p> 	<p>B5A-17322-C <i>Speedometer Gear</i> 19 teeth w/Brown 1956-62 15.00 ea.</p> 	

ORDERS ONLY 1-800-417-3347

ELECTRIC WIPER MOTOR -F100-F600

Twelve Volt -2-Speed Electric Wiper Motor Complete With Wiring & Switch.

The 1956-60 comes complete with mounting bracket.

1961-66 comes with the template to rework your existing bracket to mount the motor on.

B6C-17508-RR Complete with wiring,
switch & mounting bracket -2 speed
1956-60
160.00 ea.



CITZ-17508-RR Complete with wiring,
switch & special template to rework exist-
ing bracket to mount new motor on -Also
includes rubber pads,
to go between bracket & firewall
-2 speed,
1961-66
150.00 ea.



C7TZ-17508-D Wiper Motor -
Two Speed
1966-72
230.00 ea.



WIPER MOTOR SWITCH

B7T-17470-A Wiper Switch for use
with
electric motor
-2 speed only
1957-60
40.00 ea.



B7C-17512-A Wiper Switch to Dash
Nut
1953-60
8.50 ea.



D7TZ-17512-A Wiper Switch Nut
-F100-750
1964-72
8.00 ea.



WIPER ARMS, BLADES, & RELATED

C7TZ-17526-B Wiper Arm -
Replacement by
Trico
1961-79
25.00 ea.



B2T-17528-A Wiper Blade -Re-
placement by Trico
1953-60
20.00 ea.



B6C-17526 Wiper Arm in
Stainless Steel
-Right Hand Side
1956-60
15.00 ea.



B6C-17527 Wiper Arm in
Stainless Steel
-Left Hand Side
1956-60
15.00 ea.



B8AB-17528-A Wiper Blade -
Stainless
1956-60
20.00 ea.



CITZ-17528 Wiper Blade in Stain-
less Steel
1961-66
18.00 ea.



B6Q-17542-A Wiper Motor Clevis -Use when changing from
vacuum to electric motor,
Comes with electric motors
1956-60
20.00 ea.



CITB-17540-A Windshield Wiper Motor to,
Transmission Arm -1.46" Center Hole
to Center Hole -Black,
left- F100-1100
1961-66
21.95 ea.



C3TZ-17545-A Windshield Wiper Motor to, Transmission Arm
-1.25" Center Hole to Center Hole, right-
F100-1100
1961-66
21.95 ea.



06H-17531 Clip to Hold Wiper Arms to Motor
1949-56
1.00 ea.



WIPER PIVOT PARTS		
<p>BAAA-17541-A Wiper Pivot to Cowl Gasket 1953-60 3.00 pr.</p> 	<p>CITZ-17541 Wiper Pivot to Cowl Gasket 1961-66 5.00 pr.</p> 	<p>BAAA-17515-A Wiper Pivot Shaft Bezel or Spacer - Chrome Plated 1953-60 7.50 ea.</p> 
<p>CITZ-17514-PR Wiper Pivot Bezel 1961-66 25.00 pr.</p> 	<p>356094-S Wiper Pivot Shaft Nut -Chrome plated 1948-60 5.00 ea.</p> 	<p>370695-S Wiper Pivot Nut 1961-66 5.00 ea.</p> 
<p>B8Q-17622-A Wiper Pivot Assembly - F & T-100-1100, -Electric Wipers 1957-60 40.00 ea.</p> 	<p>CITB-17A548-A Wiper Pivot Assembly - F & T-100-1100 1961-66 45.00 ea.</p> 	
WINDSHIELD WASHER RESERVOIR PARTS		
<p>BF-17615-A Windshield Washer Valve, -Original Tooling 1957-60 27.50 ea.</p> 	<p>BM-17618 Windshield Washer Bag 1957-60 30.00 ea.</p> 	<p>BM-17632-A Cover for Washer Reservoir 1954-60 5.00 ea.</p> 
<p>B8S-17632-A Windshield Washer Reservoir Cover, -Original Tooling 1965-67 5.00 ea.</p> 	<p>99A-17543 Wiper Hose -1/4" Diameter - Sold by the foot -NON Returnable 1932-60 1.00 ft.</p> 	
<p>CIAZ-17664-C Windshield Washer Pump F100/250 1965-66 45.00 ea.</p> 	<p>B5S-17666-A Nozzle for Windshield Washer -F100-350 1957-66 15.00 ea.</p> 	
FRONT BUMPER RELATED PARTS		
<p>C1TZ-17757-J Chrome Front Bumper - 3 Mounting Holes in Front -Import, F100-350 - No License Plate Holes -No Hardware 1961-63 225.00 ea.</p> 	<p>C4TZ-17757-D Front Bumper -Chrome -Less Brackets -Imported -F100-350, -No Hardware - No License Plate Holes 1964-72 250.00 ea.</p> 	
<p>C9TZ-17A812-A Front Bumper Guard Pad, -For C4TZ-17996-A Original Guards 1965-72 15.00 ea.</p> 	<p>C4TZ-17996-A Front Bumper Guard Kit -complete with Pads, -Ford Type -F100-350-Made exactly as original will Fit -F100-350 1964-77 100.00 ea.</p> 	<p>B9A-17758 Bumper Bolt - Stainless Cap -takes 4 -7/16" x 14 x 1 3/4", w/nut & washer 1957-72 3.95 ea.</p> 

ORDERS ONLY 1-800-417-3347

REAR BUMPER -STYLE SIDE ONLY

C4TZ-17906-B Rear Bumper -Chrome -
 Style-side -Imported -F100-250
 1964-72
 200.00 ea.



REAR BUMPER -FOR STEP SIDE ONLY

BBAA-17906-A Rear Bumper -
 Cold Rolled Steel -Stepside Bed -
 No Brackets, No Bolts
 1948-66
 135.00 ea.



BBAA-17906-SS Rear Bumper
 -Polished Stainless with Bolts -
 Stepside Bed, No Brackets
 1948-66
 325.00 ea.



BB-17758-A Rear Bumper
 Bolt w/Nut & Washer
 -9/16" x 12 x 1 1/2
 1948-66
 5.00 ea.



BB-17758-SS Stainless Rear Bumper
 Bolt w/Nut and Washer -
 9/16" x 12 x 1-1/2
 1948-72
 5.00 ea.



SHOCK ABSORBERS

CITZ-18124-A Front Shock Absorber -
 F100
 1961-64 & Early 65
 46.00 ea.



C5TZ-18124-A Front Shock Absorber -
 F100
 late 1965-72
 50.00 ea.



A8C-18124-A Rear Shock
 Absorber -
 F100
 1961-64
 40.00 ea.



B6C-18125 Rear Shock
 Absorber -
 F100
 1956-60
 50.00 ea.



C5TZ-18125-C Rear Shock
 Absorber -
 F100
 1965-66
 40.00 ea.



WINDOW SHADES

CITZ-18246 Window Shades
 1961-66
 55.00 pr.



OUTER BEAUTY RINGS

Have Smooth Contoured Face -All Stainless

6A-18303-15 Outer Beauty Ring -
 15" wheels
 30.00 ea.



6A-18303-16 Outer Beauty Ring -
 16" wheels
 30.00 ea.



CAB

Firewall | Cowl

- Windshield Radio
- Glove Box
- Sunvisor
- Floor Mat
- Doors
- Rear Window
- Headliner

HEATER PARTS

B6C-18527 Heater Motor -
 Universal -12 volt
 1956-60
 87.50 ea.



BPA-18572 Heater Hose Clamp
 -5/8" All
 ALL
 1.00 ea.



B7C-18565-S Heater Seal kit for
 Fresh Air and Recir-
 culating Heater
 1957-60
 20.00 kit



CITZ-9700 Heater Knob -
 Black
 w/White Insert
 1961-66
 6.00 ea.



B7C-9700 Heater Knob in Black
 1957
 6.00 ea.



B8C-9700 Heater Knob in White
 1958-60
 6.00 ea.



DEFROSTER HOSE -ORDER BY SIZE & LENGTH

8H-18556-B Defroster Hose -
 1 3/4" I.D.-NON
 RETURNABLE
 -Sold by the foot
 6.25 ft.



FAB-18556-D Defroster Hose -
 2" I.D.-NON RE-
 TURNABLE -Sold
 by the foot
 9.00 ft.



B5A-18556-C Defroster Hose -
 2 1/2" I.D.-NON RE-
 TURNABLE -Sold
 by the foot
 10.00 ft.



RADIO RELATED PARTS

C3AZ-18813-C Radio Antenna
 -Complete with,
 Template
 -F100/1100
 1961-66
 67.50 ea.



C3AZ-18818-S Radio Antenna Base
 Pad
 1961-66
 8.00 ea.



BA-18919-A Cowl Antenna Base in
 Black Plastic,
 C-CT-H-HT
 500/1100
 1961-66
 10.00 ea.



6A-18815-S Radio Antenna Mast
 F100-1100
 1957-60
 20.00 ea.

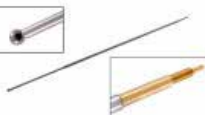

C3TZ-18830-A Radio Knob Bezels,
 Die Cast Chrome -Painted Black
 1963-66
 25.00 pr.



B8C-18817-A Radio Tone Knob -
 White Plastic -
 F100-750
 1958-60
 5.00 ea.



B7C-18817-A Radio Tone Knob -
 Black Plastic -
 F100-750
 1957
 5.00 ea.



ORDERS ONLY 1-800-417-3347

AIR CONDITIONER COMPRESSOR METAL TAG

C9AZ-19655-B A/C Compressor Crank Shaft Seal



-F100-350
1965-71
20.00 ea.

OVERDRIVE PULL CABLE GROMMET

1A-7001694 Overdrive Pull Cable Grommet



-F100
1953-71
6.00 ea.

COWL MOLDING & COWL RELATED PARTS

C5TZ-8102328-A Cowl Molding



-F100-250
1965-66
40.00 ea.

B7C-8102204-A Cowl Ventilator Grille Anti-Squeak,



set of (6)
1957-60
4.00 set

WINDSHIELD RUBBER

B7C-8103110-A Windshield Rubber -



No Chrome -Mfg. USA
1957-60
40.00 ea.

B7C-8103110-B Windshield Rubber -With Groove for



Chrome -Mfg. USA
1957-60
40.00 ea.

CIUB-8903110-A Windshield Rubber -No Chrome



-F100-F1100
1961-66
40.00 ea.
NOTE: Also fits: Econoline-All 1961-67; N-500/1100 1961-69; NT-500-1100 1961-69; F-800/1100 1961-69; T-800 1961-66; 85 F-600/1100 1961-63

CITB-8103110-B Windshield Rubber -With Groove for



Chrome -F100-F1100
1961-66
40.00 ea.
NOTE: Also fits: T-100/750 1961-66; T-800/1100 1961-69; N-500/1100 1961-69; NT-500/1100 1961-69; F-800/1100 1961-69 All model 66B Integrsl Pickup & Custom Cab 1961-63.

GLOVE BOX

NOTE: All glove box liners come with installing screws & special clips in liner that the installation screw fit into.

B7C-8106010 Glove Box Liner



Assembly
1957-60
25.00 ea.

CITZ-8106010-A Glove Box Liner



Assembly
1961-64
25.00 ea.

C5TZ-8106010 Glove Box Liner As-



sembly -with step
for heater F100-250
1965-66
25.00 ea.

0A-16378 Glove Box Door



Bumpers
1953-66
3.00 pr.

CITZ-8101656 Glove Box Door Knob





-F-N-NT-T-100/1
100
1961-66
6.00 ea.

B7C-8106112-PR Glove Box Door Spring









-F100-1100
1957-60
9.40 pr.



GLOVE BOX Continued

<p>CITZ-8106112-PR Glove Box Door Spring -F100-1100 1961-66 7.50 pr.</p> 	<p>B7A-7006122 Glove Box Arm Stop - need 2 1957-64 3.00 ea.</p> 
--	---

SUN VISOR RELATED

<p>B7C-8104104-B Sun Visor -Gray 1957-58 20.00 ea.</p> 	<p>B9C-8104104 Sun Visor -Gray 1959-60 20.00 ea.</p> 	<p>CITZ-8104104-C Sun Visor -Gray 1961-66 20.00 ea.</p> 
<p>CITZ-8104104-BLS Sun Visor -Padded -Black 1961-66 70.00 ea.</p> 	<p>CITZ-8104104-TN Sun Visor - Padded -Tan 1961-66 75.00 ea.</p> 	<p>CITZ-8104104-RD Sun Visor -Padded -Red 1961-66 75.00 ea.</p> 

NOTE: Padded visors can be dyed.

<p>C3DZ-7604114-B Sun Visor Metal Anchor Pin 1959-66 4.50 ea.</p> 	<p>CIUZ-8904132-A Sun Visor Anchor Pin Retainer Clip -F100-1100 1961-66 15.00 ea.</p> 
--	--

SUN VISOR BRACKET & ARM

<p>B6C-8104144-AP Sun Visor Bracket & Arm -Plain 1956-60 17.50 ea.</p> 	<p>B6C-8104144-CC Sun Visor Bracket & Arm -Chrome 1956-60 30.00 ea.</p> 	<p>CITZ-8104144-A Sun Visor Bracket & Arm -Right Side -Plain 1961-66 32.50 ea.</p> 
<p>CITZ-8104145-A Sun Visor Bracket & Arm -Left Side -Plain 1961-66 32.50 ea.</p> 	<p>CITZ-8104144-CC Sun Visor Bracket & Arm -Right Side -Chrome 1961-66 40.00 ea.</p> 	<p>CITZ-8104145-CC Sun Visor Bracket & Arm -Left Side -Chrome 1961-66 40.00 ea.</p> 

FLOOR MATS & CARPET

No Cutouts for Floor Shift

<p>B7C-8113000 Front Floor Mat -Replacement - No Jute Backing 1957-60 120.00 ea.</p> 	<p>CITZ-8113000 Front Floor Mat -Re- placement -No Jute Backing 1961-64 120.00 ea.</p> 	<p>CITZ-8113010-B Floor Mat -high bump -Replacement -F100-250 -No Jute Backing 1961-64 139.50 ea.</p> 
<p>C5TZ-8113000 Front Floor Mat -Replacement -No Jute Backing 1965-72 120.00 ea.</p> 	<p>C5TZ-8113010-A Front Floor Mat - Replacement -8" hump with 4-speed transmission No Jute Backing 1965-72 124.95 ea.</p> 	<p>C7TZ-8113000-B Carpet -Black - except 4-speed & C-6 -Has Padding 1965-79 225.00 ea.</p> 

ORDERS ONLY 1-800-417-3347

DOOR SCUFF PLATES

C5TZ-8113208-PR Door Scuff Plates



F100-250
1965-66
100.00 pr.

DOOR SEALS

B7C-8120530-PR Door Seals



-F100, F250, F350 -Mfg.in the USA
1957-60
90.00 pr.

CITZ-8120530-PR Door Seals



F100/1100 & T100/1100 -Mfg.in the USA
1961-66
90.00 pr.

20327-S8 Door Hinge to Body or to Door Bolt



-5/16" x 24 x 9/16"
-need 12 per door
1953-60
.75 ea.

20327-SK Bolt -Same as above -set of 50



20327-SK
Set of 50
Door Hinge Bolts
22.00 set

C0AZ-19554-A Weatherstrip Glue



-Comes in a tube
All
10.00 ea.

OUTSIDE DOOR HANDLE CUSTOM CAB NAME PLATES

C3TZ-8120966-PR Outside Door Handle



Custom Cab Name Plates F100-1100
1961-66
240.00 pr.

VENT WINDOW PARTS

B7C-8121448-PR Vent Window Seal



-Mfg.in U.S.A.
w/Rivets
1957-60
90.00 pr.

BAAA-8121450 Back Edge of Vent



Window Seal -Rub-
ber Only
1953-60
5.00 pr.

BAAA-8121450-PR Back Edge of Vent



Window Seal
1953-55
17.50 pr.

B7C-8121450-PR Back Edge of Vent Window Seal -



Rubber Molded Over Metal, -
exactly as original -w/Rivets
1957-60
17.50 pr.

CITZ-8121450-PR Back Edge of Vent Window Seal -



Rubber Molded Over Metal, -
Exactly as original -W/Rivets
1961-66
17.50 pr.

CITZ-8121448-A Vent Window



Rubber -
Right Side -
Mfg.USA -
No Rivets, -
Original Tooling
1961-66
25.00 ea.

CITZ-8121449-A Vent Window



Rubber -
Left Side -
Mfg.USA -
No Rivets, -
Original Tooling
1961-66
25.00 ea.

CITZ-8121448-PR Vent Window







Rubber -
Right/Left -
Mfg.USA -
No Rivets, -
Original Tooling
1961-66
50.00 pr.

VENT WINDOW PARTS



<p>A9AZ-7022916-A Vent Window Handle with Button - Right Side 1956-60 30.00 ea.</p> 	<p>A9AZ-7022917-A Vent Window Handle with Button -Left Side 1956-60 30.00 ea.</p> 	<p>CITZ-8122916-A Vent Window Handle -Right Side -F100- 1100, -Original Tooling 1961-66 30.00 ea.</p> 
<p>CITZ-8122917-A Vent Window Handle -Left Side -F100- 1100, - Original Tooling 1961-66 30.00 ea.</p> 	<p>C6TZ-9122926-A Vent Window Pivot Spring 1964-69 2.00 ea.</p> 	<p>8A-7022920-S Vent Window Handle Button Kit for One Handle 1951-60 5.95 kit</p> 
<p>CITZ-8122938 Vent Window Handle Shaft & Bracket -Right Side 1961-66 17.50 ea.</p> 	<p>CITZ-8122939 Vent Window Handle Shaft & Bracket -Left Side 1961-66 17.50 ea.</p> 	
<p>8A-7022938-B Vent Window Bracket & Handle Shaft As- sembly -Right Side 1957-60 15.00 ea.</p> 	<p>8A-7022939-B Vent Window Bracket & Handle Shaft As- sembly -Left Side 1957-60 15.00 ea.</p> 	

DOOR GLASS ANTI-RATTLER PARTS



1957-60

<p>B7C-8121452-PR Door Glass Anti-Rattler Kit -Stainless Edge -Complete with, clips installed - One pair does one door only 1957-60 20.00 pr.</p> 	<p>B7C-8121550-A Door Glass Run -Backside & Top -Stainless Bead 1957-60 30.00 ea.</p> 	<p>B7C-8122296-CA Complete Division Bar Assembly -Right Side 1957-60 40.00 ea.</p> 
<p>B7C-8122297-CA Complete Division Bar Assembly -Left Side 1957-60 40.00 ea.</p> 	<p>B7C-45983-PUD Complete Window Anti-Rattler Kit -Includes one Pair of #B7C- 8122296-97-CA, 2 of B7C-8121452-PR & 2 of B7C-8121550-A 175.00 kit</p>	

1961-66

<p>CITZ-8121452-B Anti-Rattler -Bead is Painted Black 1961-66 27.50 pr.</p> 	<p>CITZ-8121452-A Anti-Rattler - Bead is Stainless 1961-66 30.00 pr.</p> 	<p>CITZ-45983-PUD Window Channel Kit 1961-66 185.00 ea.</p>
---	--	--

ORDERS ONLY 1-800-417-3347

1961-66		
<p>CITZ-8122296-CA Complete Division Bar Assembly -Right Side - Complete with, brackets & back -of vent window seal 1961-66 45.00 ea.</p> 	<p>CITZ-8122297-CA Complete Division Bar Assembly -Left Side - Complete with, brackets & back -of vent window seal 1961-66 45.00 ea.</p> 	<p>CITZ-45983-PUD Complete Window Channel Kit (Deluxe for Trucks)- Includes Two each of # CITZ-8121452-A & #CITZ-8121508-A, and one each of #CITZ-8122296-CA & #CITZ, 8122297-CA 1961-66 185.00 kit</p>

DOOR LOCK CYLINDER PARTS

<p>B2A-7021942-A Door Lock Cylinder Cover w/ spring -Right Side 1957-60 10.00 ea.</p> 	<p>B7A-7021984-PR Door Lock Cyl. & Keys for both, doors (in pairs only) 1953-60 40.00 pr.</p> 	<p>BAAA-7022050-S Two Door Lock Cylinders with Two Keys & One Ignition Cylinder Assemblies 1953-60 50.00 set</p> 
<p>C3AZ-6222050-B Door Lock and Ignition Cylinder Set -F100-350 w/Keys (2 door, lock & 1 ignition) 1961-66 50.00 set</p> 	<p>B7C-8122023-A Door Lock Cylinder Retainer Clip 1957-60 5.00 ea.</p> 	<p>B7A-7022075-A Door Lock Cylinder Cover, Operating Spring 1957-60 2.50 ea.</p> 

STRIKER PLATES & RELATED PARTS

<p>353382-S Striker Plate Bolt 1953-60 2.00 ea.</p> 	<p>CITB-9122008-A Striker Plate Only -Right Side - No, Cover or Insert 1957-60 20.00 ea.</p> 	<p>CITB-9122009-A Striker Plate Only -Left Side - No, Cover or Insert 1957-60 20.00 ea.</p> 
<p>C3SZ-6322014-A Door Latch Striker Auxiliary Plate, -Right Hand 1961-66 5.00 ea.</p> 	<p>C3SZ-6322015-A Door Latch Striker Auxiliary Plate, -Left Hand 1961-66 5.00 ea.</p> 	<p>B7A-7022058-A Striker Shim 1957-60 4.00 ea.</p> 
<p>C0AZ-6222008-A Striker Plate - Right Hand No, Cover or Insert 1961-66 20.00 ea.</p> 	<p>C0AZ-6222009-A Striker Plate -Left Hand -No, Cover or Insert 1961-66 20.00 ea.</p> 	<p>358996-S Striker Plate Bolt 1961-66 1.00 ea.</p> 

STRIKER PLATES & RELATED PARTS

<p>C2AZ-6222040-A Door Latch Striker</p>  <p>Plate Insert, Right or Left side 1961-66 10.00 ea.</p>	<p>B7A-7022040-A Striker Plate Insert</p>  <p>-F100-350 1957-60 6.50 ea.</p>	<p>C0AB-6422058-A Metal Door Striker</p>  <p>Shim -F100-1100 1961-66 5.00 ea.</p>
--	--	---

DOOR PARTS



<p>C1TB-8121818-R Replacement Door Open Handle Shaft w/o Arm Assembly F100-1100 -R or L hand -Import 1961-66 30.00 ea.</p> 	<p>B7C-8121458-A Door Glass Lift Channel -F100-1100 -Right or Left 1957-60 20.00 ea.</p> 	
<p>C1TZ-8121458-A Door Glass Lift Channel -F100-1100 -Right 1961-66 30.00 ea.</p> 	<p>C1TZ-8121459-A Door Glass Lift Channel -F100-1100 -Left 1961-66 30.00 ea.</p> 	<p>8A-7021478 Door Glass Channel to Glass Tape Kit ALL 6.00 kit</p> 
<p>B7C-8121812-A Door Lock Assembly -Right Hand (Import)-F100-600 1957-60 99.95 ea.</p> 	<p>B7C-8121813-A Door Lock Assembly -Left Hand (Import)-F100-600 1957-60 99.95 ea.</p> 	<p>C3TZ-8121812-C Door Lock Assembly -Right Side -F100-1100 Import 1961-66 99.95 ea.</p> 
<p>C3TZ-8121813-C Door Lock Assembly -Left Hand (Import)- F100-1100 1961-66 99.95 ea.</p> 	<p>C1TZ-8123200-B Door Window Regulator Assembly -Right Side -F-N-NT-T-100/ 1100 1961-66 100.00 ea.</p> 	<p>C1TZ-8123201-B Door Window Regulator Assembly -Left Side -F-N-NT-T-100/ 1100 1961-66 100.00 ea.</p> 
<p>C0AB-6423240-B Window Regulator Arm Roller Assembly -Comes w/Clip 1961-66 3.50 ea.</p> 	<p>BA-7023240-A Roller Assembly for Window Regulator Arm, -Two per door -Nylon 1953-60 5.95 ea.</p> 	

INSIDE DOOR HANDLE & WINDOW ASSEMBLY

<p>B7C-8122600-B Inside Door Handle 1957-66 20.00 ea.</p> 	<p>B7C-8123342-B Window Crank Handle, w/Black Knob 1957-58 25.00 ea.</p> 	<p>B9C-8123342-B Window Crank Handle, w/White Knob 1958-60 25.00 ea.</p> 
<p>C1TZ-8123342-A Window Crank Handle, w/Black Knob 1961-66 25.00 ea.</p> 	<p>B7C-8123345 Window Crank Knob, with Pin -Black 1957 6.00 ea.</p> 	<p>B8C-8123345 Window Crank Knob, with Pin -White 1958-60 6.00 ea.</p> 



ORDERS ONLY 1-800-417-3347



INSIDE DOOR HANDLE & WINDOW ASSEMBLY

<p>CITZ-8123345 Window Crank Knob, with Pin -Black 1961-66 6.00 ea.</p> 	<p>B6C-8123205-S Window Crank Shaft, Repair Kit 1956-60 17.50 ea.</p> 
--	--

OUTSIDE DOOR HANDLES & PADS

<p>C3TZ-8122405-B Outside Door Handle -Left -F100, 1100 - Original Tooling - No Button, /with Pads and Hard- ware 1961-66 60.00 ea.</p> 	<p>BAAA-8122400-B Outside Door Handle -Right - Show, Quality -Mfg. in the USA, No Button/Pads 1953-60 60.00 ea.</p> 	<p>BAAA-8122401-B Outside Door Handle -Left -Show, Quality -Mfg. in the USA, No Button/Pads 1953-60 60.00 ea.</p> 
<p>BAAA-8122400-PR SAVE:BUY A PAIR -Outside Door, Handle - Show Quality - No Buttons/Pads 1953-60 100.00 pr.</p> 	<p>B5C-8122400-A Outside Door Handle -Genuine Ford, Right Side - w/Button/Pads & screws 1953-60 60.00 ea.</p> 	<p>B5C-8122401-A Outside Door Handle -Genuine Ford, Left Side -w/Button/Pads & screws 1953-60 60.00 ea.</p> 
<p>B9A-6422404-A Outside Door Handle -Right - Show, Quality -Mfg. in the USA -No Button/Pads 1961-66 62.50 ea.</p> 	<p>B9A-6422405-A Outside Door Handle Left -Show, Quality -Mfg. in the USA -No Button/Pads 1961-66 62.50 ea.</p> 	<p>B9A-6422404-PR SAVE:BUY A PAIR -Outside Door, Handle - Show Quality - No Button/Pads 1961-66 135.00 pr.</p> 

<p>BAAA-8122428 Outside Door Handle Pads - 4 pieces 1953-60 6.00 pr.</p> 	<p>B9A-8122428 Outside Door Handle Pads - 4 pieces 1961-66 6.00 set</p> 
---	---

<p>BAAA-8122454-A Outside Door Handle Push Button &, Guide Assembly -1 per door F-T100/ 1100 1953-60 15.00 ea.</p> 	<p>CITB-8122454-A Outside Door Handle Push Button &, Guide Assembly 1 per door -F-N-NT, T-100/1100 1961-66 15.00 ea.</p> 
---	--

WINDOW REGULATOR SHAFT REPAIR KIT

<p>B6C-8123205-S Window Regulator Shaft - Used when shaft is stopped where window crank installs 1956-60 17.50 ea.</p> 

INSIDE DOOR HANDLE SHAFT REPAIR KIT

<p>B7C-8121818-RK Inside Door Handle Shaft Repair Kit - Used when shaft is stripped 1957-60 15.00 ea.</p> 

DOOR ARM REST

B9A-6424140-BL Door Arm Rest -Black -Right Side,
-F100-F1100
1957-66
30.00 ea.



B9A-6424141-BL Door Arm Rest -Black -Left Side,
F100-F1100
1957-66
30.00 ea.



B9A-6424140-RD Door Arm Rest -Red -Right Side,
F100-F1100
1957-66
30.00 ea.



B9A-6424141-RD Door Arm Rest -Red -Left Side,
F100-F1100
1957-66
30.00 ea.



DOOR EMBLEMS

B7C-8125622-PR Door Emblem -Custom Cab Script
-F100/1100 -Mfg.USA -w/Clips
1957-60
60.00 pr.

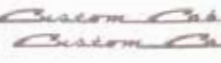

CITZ-8125622-A Door Emblem -Custom Cab Nameplate
Custom Cab Only -w/Clips
1961-66
25.00 ea.



CAB WELD IN PANELS

B7C-8140302-S Cab Back Lower Corner Panel -
Right Side
1957-60
80.00 ea.

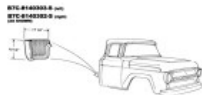

B7C-8140303-S Cab Back Lower Corner Panel -
Left Side
1957-60
80.00 ea.

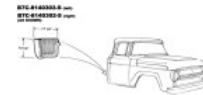

CITZ-8140302-S Cab Back Lower Corner -
Right Side
1961-66
65.00 ea.



CITZ-8140303-S Cab Back Lower Corner -
Left Side
1961-66
65.00 ea.



REAR CAB MOULDINGS

C5TZ-8142316-PR Rear Cab Mouldings -
With clips
1965-66
70.00 pr.



BACK WINDOW RUBBER

B7C-8142084-A Back Window Rubber -
Use WITHOUT wrap around back glass -
Mfg.USA
1957-60
30.00 ea.



B7C-8142084-B Back Window Rubber -
Use WITH wrap around back glass -Mfg.
USA -w/Groove For Chrome
1957-60
55.00 ea.



CITB-8142084-A Back Window Rubber -Use WITHOUT wrap around back glass F-N-NT 100/1100 Conventional Cab 1961-66, F-T800 /1000,N-NT 500 /1000 1967-69, F100/250 -Model 66 Integral or Unitized Body Pickups without wrap around glass 1961-63 1961-69
40.00 ea.



CITZ-6642084 Back Window Glass Rubber -Model 66
Integral or Unitized Body P/ups with wrap
around back glass -F100/250
1961-63
65.00 ea.



B7C-8242084-P Panel Back Window Seals
1957-60
65.00 pr.



ORDERS ONLY 1-800-417-3347

DOOR HINGE PINS & BOLTS

B9A-5943030-A Door Hinge Pin -

 **Cut to length**
1957-67
3.00 ea.

20327-S8

Door Hinge to Door Bolts -

 **12 per Door**
1953-60
.75 ea.

DOOR PANELS

CITZ-8123890-PR Door Panels -Molded Plastic -

 **White**
1961-66
100.00 pr.

HEADLINER KITS

Perforated Board - painted light grey with original chicken track design

B7C-8151992-A Headliner with wrap

around rear glass -
3 pieces
1957-60
150.00 kit



CITB-6651968-A Headliner Without

Wrap Around Rear
Glass -
2 pieces
Unibody -comes
with clip kit,
1961-63
150.00 kit



CITZ-6651945-A Headliner with Wrap

Around Rear Glass -
1 piece -Unibody
comes with clip kit
1961-63
150.00 kit

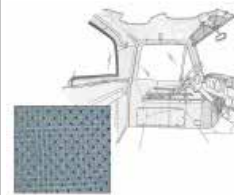

CITZ-8151968-A Headliner Kit -2 pieces -comes with clip kit -All

except unibody
1961-64
150.00 kit



C5TZ-8151968-A Headliner Kit -

4 pieces -comes with clip kit
1965-66
175.00 kit



Headliners are Oversize. Call for shipping prices.

NO Holes with original chicken track design,

B7C-8151968-PL Headliner Without

Wrap Around Rear
Glass
-4 pieces
no screws
1957-60
150.00 kit



B7C-8151992-PL Headliner With Wrap

Around Rear Glass
-
3 pieces
no screws
1957-60
150.00 kit



CITB-6651968-PL Headliner Without

Wrap Around Rear
Glass -
2 pieces
Unibody -Comes
with Clip Kit
1961-63
150.00 kit



CITZ-6651945-PL Headliner With

Wrap Around Rear
Glass -
1 Piece -Unibody
Comes with
clip kit,
1961-63
150.00 kit

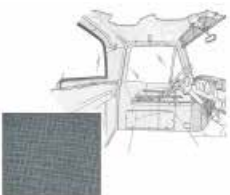

CITZ-8151968-PL Headliner -2 pieces

-Comes with
clip kit
1961-64
150.00 kit

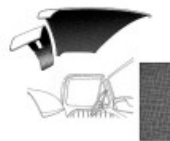

C5TZ-8151968-PL Headliner -4 pieces

-Comes with
clip kit
1965-66
175.00
kit

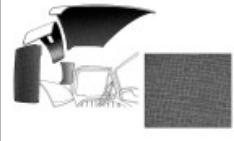

HEADLINER CLIP

CITZ-6652118-KIT Headliner Clip Kit -



Comes with Headliners
1961-66
16.00 kit

BED

Bed Parts

STEP SIDE/BED PARTS

7C-8144440 Counter Sunk Washer -



Cold Rolled Steel -Cadium Plated
1948-72
1.50 ea.

7C-8144440-SS Counter Sunk Washer -



Stainless Steel
1948-72
3.00 ea.

350620-S8 Bed to Frame Bolt for Front of Bed -



7/16" x 20 threads
Need 2 per bed -no nuts -Round Head
-zinc plated
1948-63
3.00 ea.

350623-S Bed to Frame Bolt -



7/16" x 20 threads -Need 4 per bed
No nuts, goes with above washer -Counter Sunk Head -zinc plated
1948-63
3.50 ea.

34447-S2 Self Locking Nut for



Bed to Frame Bolts
(350620-S8 &
350623-S)
1948-63
1.00 ea.

BAAA-8300124-A Front of Box Panel



-Pick-up with 110",
114", 115" wheel
base
1952-72
150.00 ea.

BAAA-8310608-A Rear Bed Runner



1951-66
80.00 ea.

BAAA-8327840-A Bed Side



-Right Side -
Step Side
1953-72
325.00 ea.

BAAA-8327841-A Bed Side -

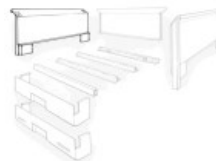

Left Side -
Step Side
1953-72
325.00 ea.

8C-8110609-CR Bed Board End Cap



Strip at Rear -Steel
1948-72
15.00 ea.

8C-8110609-SS Bed Board End Cap



Strip at Rear
-Stainless
1948-72
30.00 ea.

8C-8110611-PR Front Bed Metal Cross



Member to Bed
Wood Spacer
1948-72
4.00 pr.

355471-S8 Special Bolt to Fasten Rear Fenders to Bed



Sides -5/16" x 24, 5/8" -as original
1948-72
1.00 ea.

355471-SET Same as above -



Set of 24
1948-72
20.00 set

355471-SS Rear Fender to Bed Bolt -



Stainless Steel -5/16" x 24 x 5/8"
1948-72
2.00 ea.



355471-SSK Rear Fender to Bed Bolt Kit -



Stainless Steel Kit -Set of 24,
-5/16" x 24 x 5/8"
1948-72
40.00 kit

ORDERS ONLY 1-800-417-3347

TAILGATE & RELATED PARTS

<p>B7C-8340700-A Tailgate for Step Side Only - K1110", 114" 115" wheel base, Original Tooling -Short Bed -no hardware 1953-72 375.00 ea.</p> 	<p>B7D-8340700-A Tailgate for Step Side Long Bed no hardware, 118" Wheel Base -F100-350 1957-60, 120";122";128";129";&131" Wheel Base F100, F250/350 1961-63, 1957-63 400.00 ea.</p> 	
<p>C1TZ-6640702-C Unibody Tailgate 66 19/32" F100-250 -no hardware IMPORTED 1961-63 479.95 ea.</p> 	<p>C7TZ-9940700-A Tailgate -Style Side -replacement for 1964- 66 -No Hardware, -Original Tooling 1964-66 400.00 ea.</p> 	
<p>BAAA-8340725-A Side of Tailgate to Bed Bumper -Goes in Tailgate Side 1953-72 5.00 pr.</p> 	<p>81C-830860 Tailgate Hinge -Step Side -Plain 1942-72 8.50 ea.</p> 	<p>81C-830860-SS Tailgate Hinge -Step Side -stainless 1942-72 17.50 ea.</p> 
<p>8C-8343018-SS Tailgate Hinge -Step Side -stainless 1942-72 20.00 ea.</p> 	<p>TG-8344456-PR Tailgate Latches in Top Roll of Gate for Step Side Beds- F100-250 1953-79 120.00 pr.</p> 	<p>BAAA-8344456-A Tailgate Chains & Brackets -Rubbers are included 110", 114", 115" wheel base 1953-72 80.00 pr.</p> 
<p>BAAA-8344456-SS Tailgate Chains & Brackets -Same as above except these are stainless 1953-72 120.00 pr.</p> 	<p>B3TZ-8344456-D Tailgate Chains for Style Side Bed -will work but eye bolt is long (add washer)- Plain 1957-63 80.00 pr.</p> 	<p>B3TZ-8344456-SS Tailgate Chains for Style Side Bed -will work but eye bolt is long (add washer)-Stain- less 1957-63 150.00 pr.</p> 
<p>BAAA-8344458-S Tailgate Chain Special Rubber Bumper that fits in bracket 1953-72 5.00 pr.</p> 	<p>7C-8144450-S Tailgate Chain Rub- ber Covers 1948-72 10.00 pr.</p> 	<p>C4TZ-99431D72-S Tailgate release lever and bolt assy.- F100-250 1964-72 15.00 set</p> 

TAILGATE & RELATED PARTS -Continued

<p>C4TZ-99431C78-B Tailgate Latch Release Handle Mounting Plate -Cadium Plated 1964-1972 30.00 ea</p> 	<p>C4TZ-99431C78-SS Tailgate Latch Release Handle Mounting Plate -Stainless Steel Style side bed -F100-250 1964-72 40.00 ea.</p> 	<p>C4TZ-99431D76-A Tailgate Latch Assembly -R or L hand -F100-250, -Original Tooling 1964-72 45.00 ea.</p> 
<p>C4TZ-99431B54-A Tailgate Latch on Bed Side -Style Side F100/250 1964-72 15.00 ea.</p> 	<p>C4TZ-9943000-A Tailgate Hinge 1964-79 25.00 ea.</p> 	
<p>C4TZ-99431B82-A Tailgate Latch Release Handle -Zinc, Plated -Style side -F100/250 1964-72 25.00 ea.</p> 	<p>C7TZ-99431B82-A Tailgate Latch Release Handle, Chrome Plated -Style Side -F100/250 1964-72 33.00 ea.</p> 	<p>C7TZ-99431B82-SS Tailgate Latch Release Handle, Stainless -Style Side -F100/250 1964-72 30.00 ea.</p> 
<p>C4TZ-9944400-A Tailgate Support -Style Side -F100/250, -Original Tooling 1964-66 35.00 ea.</p> 	<p>C4TZ-9944482-A Tailgate Support Retaining Bumper, Need two per truck -F100/250 1964-66 5.50 ea.</p> 	
<p>C4TZ-9940224 Tailgate Upper Bumpers -F100-250 1964-72 4.00 pr.</p> 	<p>52363-S4 Tailgate Latch Release Handle, Mounting Plate Screws -stainless screws set of 4 -style side -F100/ 250 1964-72 2.00 set</p> 	

BED SIDE MOLDINGS

Bedside Moldings -Sold in Pairs Only -With Installation Clips -Exact Duplicate of Original

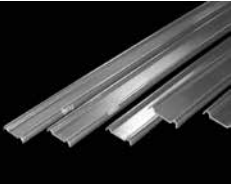
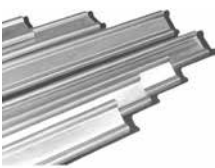

<p>C5TZ-9929038-BPR Short Wheel Base 1965-66 200.00 pr.</p> 	<p>C5TZ-9929038-APR Long Wheel Base 1965-66 220.00 pr.</p> 	<p>C5AZ-6310198-A Bedside Molding Clip 13 per side Short Bed, 17 per side Long Bed 1965-66 2.75 ea.</p> 
--	---	---

BED STRIPS -EXACTLY AS ORIGINAL -NO HOLES

<p>7C-8112605-CRU Bed Strips -Cold Rolled Steel 76 3/4" -Set of 7 59.50 set</p> 	<p>7C-8112605-SSU Bed Strips -Bright Stainless Steel 76 3/4" -Set of 7 130.00 set</p> 
---	--

ORDERS ONLY 1-800-417-3347

BED STRIPS - EXACTLY AS ORIGINAL - NO HOLES

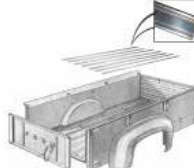
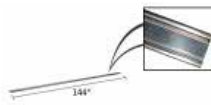
<p>7C-8112605-SSUP Bed Strips -Bright Stainless Steel Polished</p>  <p>76 3/4" -set of 7 220.00 set</p>	<p>BAAA-8112605-CRU Bed Strips -Cold Rolled Steel 95" -Set of 7</p>  <p>50.00 set</p>
<p>BAAA-8112605-SSU Bed Strips -Bright Stainless Steel 95" -Set of 7</p>  <p>150.00 set</p>	<p>B6C-8112605-SS Bed Strip -Stainless Steel 144" (12')</p>  <p>30.00 ea.</p>

NOTE: Bed Strips 108" & 144" long must be shipped by commercial truck lines freight collect.

BOLTS FOR ABOVE STRIPS -NO HOLES









These bolts have knurled underheads. To install, first drill a 9/32" hole in the strip for a press fit

<p>BAAA-8112612-PF Bolt Kit -plain finish -zinc plated nut & lock washer</p>  <p>63 bolts & 21 large flat washers 35.00 kit</p>	<p>23503-P Bolt only - plain finish .60 ea.</p> 
---	---

MISCELLANEOUS

- Decals Books Bulbs Moldings Bolts
- Motor Mount Kits
- Patch Panels
- Key Chains
- Electric Sign

AIR CLEANER DECALS

<p>DF-350 Positive Crankcase Vent Decal</p>  <p>1962-66 4.50 ea.</p>	<p>DF-466 Air Cleaner Decal -352/208 H.P.</p>  <p>1965-66 4.50 ea.</p>	<p>DF-467 Air Cleaner Decal -223/139 H.P.</p>  <p>1957-60 6.50 ea.</p>
<p>DF-468 Air Cleaner Decal -292/160 H.P.</p>  <p>1961-64 4.50 ea.</p>	<p>DF-469 Air Cleaner Decal -240/150 H.P.</p>  <p>1965-67 6.00 ea.</p>	<p>DF-470 Air Cleaner Decal -272/171 H.P.</p>  <p>1957-58 6.50 ea.</p>
<p>DF-488 Air Cleaner Decal -292/172 H.P.</p>  <p>1958-60 6.50 ea.</p>	<p>DF-489 Air Cleaner Decal -272/181 H.P.</p>  <p>1959-60 6.50 ea.</p>	<p>DF-487 Air Cleaner Decal -223/135 H.P.</p>  <p>1961-64 4.50 ea.</p>



















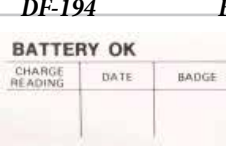



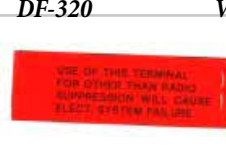

VALVE COVER DECALS

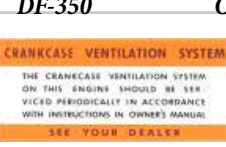
DF-70 *Ford V-8 Valve Cover Decals*



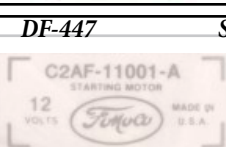

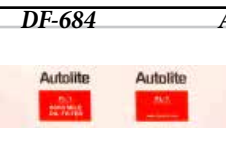
1957-60
17.50 pr.

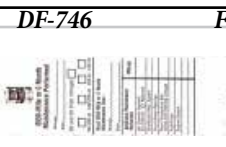
ENGINE COMPARTMENT DECALS

<p>DF-20 <i>Service Specification</i></p>  <p><i>Decal</i> 1965-66 4.00 ea.</p>	<p>DF-32 <i>Voltage Regulator</i></p>  <p><i>Decal</i> 1956-57 5.00 ea.</p>	<p>DF-33 <i>Coil Decal</i></p>  <p>1956-62 5.00 ea.</p>
<p>DF-69 <i>Generator Decal</i></p>  <p>1957 5.00 ea.</p>	<p>DF-83 <i>Air Cleaner Service</i></p>  <p><i>Instructions</i> 1957-65 5.00 ea.</p>	<p>DF-107 <i>Voltage Regulator</i></p>  <p><i>Decal</i> 1958-60 5.00 ea.</p>
<p>DF-120 <i>FoMoCo Antifreeze</i></p>  <p><i>Tag</i> 1955-63 5.00 ea.</p>	<p>DF-131 <i>Starter Decal</i></p>  <p>1956-57 5.00 ea.</p>	<p>DF-164 <i>Oil Cap Decal</i></p>  <p>1960-65 4.00 ea.</p>
<p>DF-194 <i>Battery Test Decal</i></p>  <p>1964-68 4.00 ea.</p>	<p>DF-224 <i>Coil Decal</i></p>  <p>1965-70 4.00 ea.</p>	<p>DF-229 <i>Engine Foundry Tag</i></p>  <p>1954-58 5.00 ea.</p>
<p>DF-280 <i>Fuel Filter Decal</i></p>  <p>1962-65 4.00 ea.</p>	<p>DF-320 <i>Voltage Regulator</i></p>  <p><i>Warning Tag</i> 1962-66 4.00 ea.</p>	<p>DF-337 <i>Voltage Regulator</i></p>  <p><i>Decal</i> 1962 5.00 ea.</p>
<p>DF-345 <i>Service Specification</i></p>  <p><i>Decal</i> 1964 4.00 ea.</p>	<p>DF-347 <i>Voltage Regulator</i></p>  <p><i>Warning Decals</i> 1962-64 6.00 pr.</p>	<p>DF-350 <i>Crankcase Vent Decal</i></p>  <p>1960-65 4.50 ea.</p>
<p>DF-351 <i>Air Conditioner</i></p>  <p><i>Aluminum Tag</i> 1966 6.00 ea.</p>	<p>DF-405 <i>Battery Test Decal</i></p>  <p>1962-63 4.00 ea.</p>	<p>DF-412 <i>Voltage Regulator</i></p>  <p><i>Decal</i> 1965-66 6.00 ea.</p>
<p>DF-447 <i>Starter Decal</i></p>  <p>1962-64 5.00 ea.</p>	<p>DF-515 <i>Generator Decal</i></p>  <p>1962-64 5.00 ea.</p>	<p>DF-647 <i>Rotunda 6000 Gold</i></p>  <p><i>Oil Filter Decal</i> 1964-69 5.00 ea.</p>
<p>DF-684 <i>Autolite FL-1 Oil</i></p>  <p><i>Filter Decal</i> 1964-69 5.00 ea.</p>	<p>DF-699 <i>Rotunda Antifreeze</i></p>  <p><i>Tag</i> 1964-66 6.00 ea.</p>	<p>DF-746 <i>Ford 6000 or Six</i></p>  <p><i>Month Lube Sticker</i> 4.50ea.</p>

ORDERS ONLY 1-800-417-3347





ENGINE COMPARTMENT DECALS Continued

<p>DF-991 PCV Plastic Ring -352/390</p>  <p>1965-71 6.00 ea.</p>	<p>DF-1125 Generator Warning Tag -Green -12 Volt</p>  <p>1957-64 3.50 ea.</p>
---	--

INTERIOR DECALS

<p>DF-951 Glove Box Oil Pressure Decal</p>  <p>7.50 ea.</p>	
--	--







FORD LETTER DECALS FOR TAILGATE STEP SIDE ONLY

<p>DF-688 Ford Letters -Blue</p>  <p>1953-72 15.00 set</p>	<p>DF-689 Ford Letters -White</p>  <p>1953-72 15.00 set</p>	<p>DF-690 Ford Letters -Black</p>  <p>1953-72 15.00 set</p>
<p>DF-691 Ford Letters -Silver</p>  <p>1953-72 15.00 set</p>	<p>DF-692 Ford Letters -Red</p>  <p>1953-72 15.00 set</p>	

MISCELLANEOUS ITEMS

<p>23501-P Fine Threaded Carriage Bolt -Plain Finish 1 1/2" long All 1.00 ea.</p> 	<p>24367 Fine Threaded Carriage Bolt -7/8" long All .50 ea.</p> 	<p>34447-S2 Self Locking Nuts for Bed to Frame Bolt -(350620-S8 &, 350623-S) 1948-63 1.00 ea.</p> 
<p>357479-S Pin Gear Shift Lever 1956-61 .75 ea.</p> 	<p>352488-S Plug to fill Door Mirror Bracket Hole 1953-66 3.00 ea.</p> 	<p>352873-S Metal Wire Grommet -Small 11/16" Fits into 11/16" dia. hole 5.50 ea.</p> 
<p>352873-L Metal Wire Grommet -Large 25/32" RH or LH side of Radiator Support -F100-1100 1957-63 4.00 ea.</p> 	<p>359422-S Ash Tray Door Bumpers 3.00 pr.</p> 	<p>359553-S Steering Wheel Nut -F100/600 1948-62 3.95 ea.</p> 
<p>355471-S8 Special Bolt to Fasten Rear Fender to Bed Side 1948-72 1.00 ea.</p> 	<p>353382-S Striker Plate Bolt 1953-60 2.00 ea.</p> 	<p>358871-S Air Cleaner Wing Nut 2.00 ea.</p> 







MISCELLANEOUS ITEMS Continued

<p>370695-S Wiper Pivot Nut 1961-66 5.00 ea.</p> 	<p>356094-S Wiper Pivot Nut 1948-60 5.00 ea.</p> 	<p>379668-S Bolt for Front & Rear Spring 1965-72 3.75 ea.</p> 
<p>376875-S Plastic Tie Strap in black -7.5" long .25 ea.</p> 	<p>72054-S Cotter Pin for Front Wheel 1932-66 .25 ea.</p> 	
<p>20327-S8 Door Hinge to Body or to Door Bolt -5/16" x 24 x 9/16" -need 12 per door 1953-60 .75 ea.</p> 	<p>20327-SK Bolt -Same as above -set of 50 22.00 set</p> 	

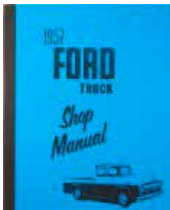
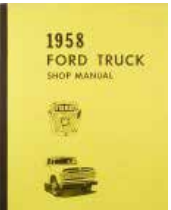
COWL & FLOOR PAN RUBBER PLUGS

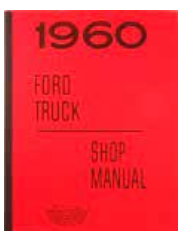

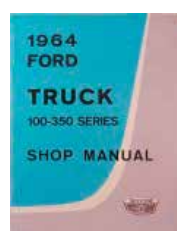
<p>352291-S Cowl & Floor Pan Rubber Plug for 3/4" hole plug 2.00 ea.</p> 	<p>352284-S Cowl & Floor Pan Rubber Plug for 1 1/4" hole plug 2.00 ea.</p> 
<p>352285-S Cowl & Floor Pan Rubber Plug for 1 1/2" hole plug 2.00 ea.</p> 	<p>357216-S Cowl & Floor Pan Rubber Plug for 1 3/4" (1.87) hole 2.00 ea.</p> 

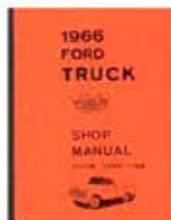
SHOP MANUALS

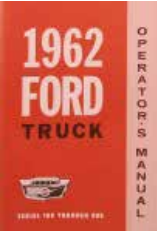
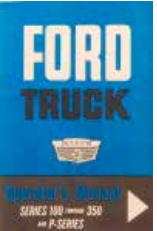
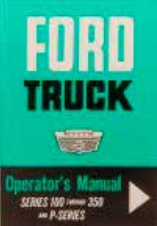

<p>TR-5700 Shop Manual 1957 55.00 ea.</p> 	<p>TR-5800 Shop Manual 1958 55.00 ea.</p> 	<p>TR-5900 Shop Manual 1959 60.00 ea.</p> 
<p>TR-6000 Shop Manual 1960 55.00 ea.</p> 	<p>TR-6100 Shop Manual 1961 60.00 ea.</p> 	<p>TR-6400 Shop Manual 1964 60.00 ea.</p> 
<p>TR-6500 Shop Manual -2 volumes 1500 Pages 1965 100.00 set</p> 		<p>TR-6600 Shop Manual -3 volumes 1454 Pages 1966 100.00 set</p> 

ORDERS ONLY 1-800-417-3347



OPERATORS MANUALS

<p>TR-6110 <i>Operators Manual</i></p>  <p>1961 10.00 ea.</p>	<p>TR-6210 <i>Operators Manual</i></p>  <p>1962 10.00 ea.</p>	<p>TR-6310 <i>Operators Manual</i></p>  <p>1963 10.00 ea.</p>
<p>TR-6410 <i>Operators Manual</i></p>  <p>1964 10.00 ea.</p>	<p>TR-6610 <i>Operators Manual</i></p>  <p>1966 12.00 ea.</p>	

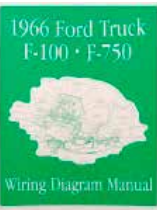
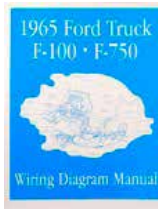

WIRING DIAGRAM MANUAL

<p>MP-364 <i>Wiring Diagram Manual -F100-750</i></p>  <p>1963 8.00 ea.</p>	<p>MP-365 <i>Wiring Diagram Manual -F100-750</i></p>  <p>1964 8.00 ea.</p>
<p>MP-366 <i>Wiring Diagram Manual -F100-750</i></p>  <p>1966 9.00 ea.</p>	<p>MP-367 <i>Wiring Diagram Manual -F100-750</i></p>  <p>1965 6.00 ea.</p>

BOOKS & LITERATURE

<p>AM-0133 <i>Body Interior Trim Assembly Manual</i></p>  <p>1957 25.00 ea.</p>	<p>TR-5715-SET <i>Ford Truck Parts & Accessories -Three Volumes</i></p>  <p>1957-63 250.00 set</p>
--	--





FACTS MANUAL

<p>MP-0301 <i>Illustrated Facts and Feature Manual -F100-</i></p>  <p>350 1957-58 7.00 ea.</p>	<p>MP-0272 <i>Illustrated Facts and Feature Manual -F100-</i></p>  <p>250 1965-66 10.00 ea.</p>
---	---

BULBS

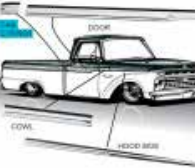
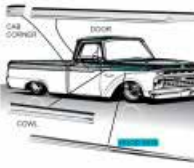



<p>B6A-13007 Headlight Bulb -#6014- 12 volt 1956-57 8.00 ea.</p> 	<p>B8AZ-13007-A Headlight Bulb -#4000 Outer Low Beam -12 volt 1958-60 10.00 ea.</p> 	<p>B8AZ-13007-B Headlight Bulb -#4001 Inner High Beam -12 volt 1958-60 10.00 ea.</p> 
<p>B6A-13007 Headlight Bulb -#6014 - 12 volt 1961-66 8.00 ea.</p> 	<p>B6A-13465-1034 Parking Light Bulb -#1034 - 12 volt 1956-62 1.50 ea.</p> 	<p>C3AZ-13466-1157 Parking Light Bulb -#1157 - 12 volt 1963-66 1.50 ea.</p> 
<p>B7A-13466-1157A Parking Light Bulb -#1157-A - 12 volt -Painted Amber 1956-66 2.00 ea.</p>	<p>B7A-13466-1157NA Parking Light Bulb -#1157N -Natural Amber -12 volt 1956-66 2.00 ea.</p> 	<p>B6A-13466-1445 High Beam Indicator Bulb -#1445 - 12 volt 1956-66 1.00 ea.</p> 
<p>B6A-13466-57 Glove Compartment Bulb -#57 -12 volt 1956-66 1.00 ea.</p> 	<p>B6A-13465-1034 Tail light Bulb - #1034 - 12 volt 1956-62 1.50 ea.</p> 	<p>C3AZ-13466-1157 Tail light Bulb - #1157 - 12 volt 1963-66 1.50 ea.</p> 
<p>09B-13466-67 Rear License Plate Lamp -#67 - 12 volt -Lamp below tailgate 1957-63 1.00 ea.</p> 	<p>C3AZ-13466-97 Rear License Plate Lamp -#97 - 12 volt 1964-66 1.00 ea.</p> 	<p>B6A-13730-1003 Dome Light Bulb -#1003 - 12 volt 1956-66 1.50 ea.</p> 

BODY MOLDINGS

<p>C5TZ-8102328-A Cowl Moulding -F100-F250 - with clips 1965-66 40.00 ea.</p> 	<p>C5TZ-8142316-PR Rear Cab Mouldings with Clips 1965-66 70.00 pr.</p> 	<p>C5TZ-16722-A Hood Side Moulding w/ Clips - Right or Left hand 1965-66 120.00 ea.</p> 
<p>C5TZ-8120938-PR Door Moulding w/Clips 1965-66 230.00 pr.</p> 	<p>C5TZ-9929038-BPR Bedside Moulding - Short Wheel Base -w/clips 1965-66 200.00 pr.</p> 	<p>C5TZ-9929038-APR Bedside Moulding - Long Wheel Base -w/clips 1965-66 220.00 pr.</p> 







ORDERS ONLY 1-800-417-3347

LICENSE PLATE BOLT

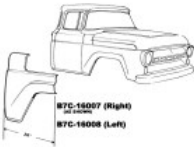
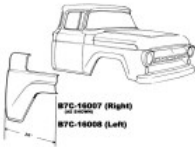
<p>LP-2A License Plate Bolt with Glass Reflector - Amber -Mfg.USA</p>  <p>10.00 ea.</p>	<p>LP-2B License Plate Bolt with Glass Reflector -Blue -Mfg.USA</p>  <p>10.00 ea.</p>
<p>LP-2G License Plate Bolt with Glass Reflector -Green -Mfg.USA</p>  <p>10.00 ea.</p>	<p>LP-2R License Plate Bolt with Glass Reflector -Red -Mfg.USA</p>  <p>10.00 ea.</p>

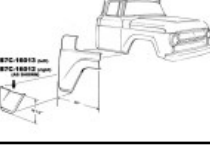



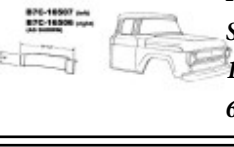
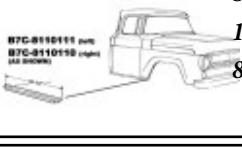
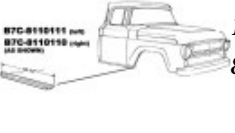
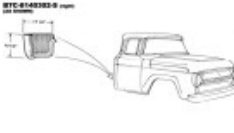
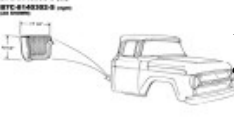

WELD-IN ROCKER PANELS

1957-60

<p>B7C-16007 Front Fender Lower Rear Panel Right Side 1957-60 110.00 ea.</p> 	<p>B7C-16008 Front Fender Lower Rear Panel Left Side 1957-60 110.00 ea.</p> 	<p>B7C-16012 Front Fender Lower Rear Panel -Tip Only Right Side 1957-60 80.00 ea.</p> 
<p>B7C-16013 Front Fender Lower Rear Panel -Tip Only Left Side 1957-60 80.00 ea.</p> 	<p>B7C-16450 Running Board Step Plate Right Side 1957-60 60.00 ea.</p> 	<p>B7C-16451 Running Board Step Plate Left Side 1957-60 60.00 ea.</p> 
<p>B7C-16506 Running Board Step Plate Riser Right Side 1957-60 60.00 ea.</p> 	<p>B7C-16507 Running Board Step Plate Riser Left Side 1957-60 60.00 ea.</p> 	<p>B7C-8110110 Rocker Panels Right Side 1957-60 80.00 ea.</p> 
<p>B7C-8110111 Rocker Panels Left Side 1957-60 80.00 ea.</p> 	<p>B7C-8140302-S Cab Back Lower Corner Panel Right Side 1957-60 80.00 ea.</p> 	<p>B7C-8140303-S Cab Back Lower Corner Panel Left Side 1957-60 80.00 ea.</p> 

WELD-IN ROCKER PANELS

1961-66

<p>CITZ-16001 Front Fender Lower Front Panel Right Side 1961-66 90.00ea.</p> 	<p>CITZ-16002 Front Fender Lower Front Panel Left Side 1961-66 90.00ea.</p> 	<p>CITZ-16007 Front Fender Lower rear Panel Right Side 1961-66 109.95 ea.</p> 
<p>CITZ-16008 Front Fender Lower rear Panel left Side 1961-66 109.95 ea.</p> 	<p>CITZ-16012 Front Fender Lower Rear Panel -Tip Only Right Side 1961-66 80.00 ea.</p> 	<p>CITZ-16013 Front Fender Lower Rear Panel -Tip Only Left Side 1961-66 80.00 ea.</p> 

WELD-IN ROCKER PANELS

1961-66

CITZ-16450 Running Board
 Step Plate Right
 Side

 1961-64
 49.95 ea.

CITZ-16451 Running Board
 Step Plate Left
 Side

 1961-64
 49.95 ea.

CITZ-16506 Running Board
 Step Plate Riser
 Right Side

 1961-64
 60.00 ea.

CITZ-16507 Running Board Step
 Plate Riser Left Side

 1961-64
 50.00 ea.

CITZ-8102042 Lower Hinge Pillar
 Repair Panel -F100-
 750 Right Side

 1961-66
 79.95 ea

CITZ-8102043 Lower Hinge Pillar
 Repair Panel -F100-
 750 Left Side

 1961-66
 79.95 ea.

C5TZ-10112A70 Front Cab Mount
 Right Side

 1965-72
 85.00 ea.

C5TZ-10112A71 Front Cab Mount
 Left Side

 1965-67
 85.00 ea.

CITZ-8110110 Rocker Panel
 Right Side

 1961-64
 30.00 ea.

CITZ-8110111 Rocker Panel
 Left Side

 1961-64
 30.00 ea.

CITZ-8110110-PR Rocker Panel Set
 Left & Right

 1961-64
 60.00 pr.

C5TZ-8110110 Rocker Panel
 Right Side

 1965-66
 30.00 ea.

C5TZ-8110111 Rocker Panel
 Left Side

 1965-66
 30.00 ea.

C5TZ-81111B80-A Cab Mount
 Inspection Plate -
 2 per truck

 Inspection plates are
 for reproduction Cab
 mounts
 1965-79
 10.00 ea.

CITZ-8120200 Door Lower Repair
 Panel Right or Left

 1961-66
 65.00 ea.

CITZ-8140302-S Cab Back Lower
 Coner Panel
 Right Side

 1961-66
 65.00 ea.

CITZ-8140303-S Cab Back Lower
 Coner Panel
 Left Side

 1961-66
 65.00 ea.

C5TZ-8110624 Floor Pan Center
 Reinforcement Ends

 1965-72
 80.00 ea.

C7TZ-1011135-R Floor Pan -Front
 Section -Right side

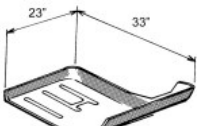
 -23" x 33" F100/350
 1965-72
 67.00 ea.

CITZ-8111106 Front Floor Pan
 -Right Hand -F100-
 350 -23 1/2" x 24"

 1961-64
 110.00 ea.

CITZ-8111107 Front Floor Pan -
 Left Hand -F100-350
 -23 1/2" x 27"

 1961-64
 110.00 ea.

CITZ-8111106-PR Front Floor Pan in Pairs
 -F100-350

 1961-64
 220.00 Pr

ORDERS ONLY 1-800-417-3347

Index

A

ACCELERATOR PEDAL 30
A/C COMPRESSOR CRANK SHAFT SEAL 52
AIR CLEANER DECALS 30, 64
AIR CLEANER FILTER 30
AIR CONDITIONER COMPRESSOR METAL TAG 52
ANTENNA 51
ARM REST 59
Ash Tray Door Bumpers 66
AUTOMATIC TRANSMISSION GEAR SHIFT INDICATOR DIAL 43
AUTOMATIC TRANSMISSION RELATED PARTS 24, 25
AXLE AND RADIUS ARM KIT 10
AXLE BUMPERS 9
AXLE PARTS 12
AXLE PIVOT BUSHING & RADIUS ROD BUSHINGS 9

B

BACK WINDOW RUBBER 59
BATTERY RELATED PARTS 32
BEAUTY RING 4, 50
BEAUTY RINGS 50
BED 61, 64
BED RUNNER 61
BED SIDE MOLDINGS 63
BEZEL CLUSTER RELATED PARTS 32
BODY MOLDINGS 69
BOOKS & LITERATURE 68
BRAKE ADJUSTING HOLE COVER 7
BRAKE DRUM 4
BRAKE HOSES 7
BRAKE LIGHT SWITCHES 41
BRAKE PARTS 5
BRAKE PEDAL 8
BRAKE RETRACTING SPRING 5
BRAKE SHOES & LININGS 5
BULBS 69
BUMPER 49, 50
BUMPER RELATED PARTS 49

C

CAB 51
CAB TO FRAME MOUNTING KIT 13
CAB WELD IN PANELS 59
CAMSHAFT 19
CAMSHAFT & RELATED 19
CARBURETOR REPAIR KITS 30
CARPET 53
CHOKE PLATE SWIVEL 29

CLOCK CABLE ASSEMBLY 30
CLUTCH, BRAKE PEDAL & RELATED PARTS 8
CLUTCH KITS 26
CLUTCH PARTS 25, 26
CONNECTING ROD & RELATED 18
COWL & FLOOR PAN RUBBER PLUGS 67
COWL MOLDING 52
COWL TO FENDER SEALS 44
CRANKSHAFT & RELATED 19
CUSTOM CAB NAME PLATES 54
CYLINDER HEAD GASKET 17

D

DASH KNOBS 34
DECALS 30, 64, 65, 66
DEFROSTER HOSE 51
DOME LIGHT PARTS 42
DOOR ARM REST 59
DOOR EMBLEMS 59
DOOR GLASS ANTI-RATTLER PARTS 55
DOOR HANDLE CUSTOM CAB NAME PLATES 54
DOOR HANDLES 57, 58
DOOR HINGE PINS & BOLTS 60
DOOR LOCK CYLINDER PARTS 56
DOOR PANELS 60
DOOR PARTS 57
DOOR SCUFF PLATES 54
DOOR SEALS 54
DRAG LINKS 10
DRIVE GEAR 47
DRUM 4

E

ELECTRICAL 31
ELECTRIC FUEL PUMPS 29
ELECTRIC WIPER MOTOR 48
ELECTRONIC IGNITION SYSTEM 35
EMERGENCY FLASHER BEZEL 43
ENGINE COMPARTMENT DECALS 65, 66
ENGINE MANIFOLDS 29
ENGINE TEMPERATURE SENDER 32
EXHAUST DEFLECTORS 13

F

FACTS MANUAL 68
FENDERS 44
FENDER WELT 44
FLEXIBLE FUEL LINES 29
FLOOR MATS & CARPET 53
FLOOR PAN 71
FLOOR SEALS 10
FLYWHEEL PARTS 20
FORD LETTER DECALS FOR TAILGATE 66

FORD SCRIPTS 44
FRONT AXLE AND RADIUS ARM KIT 10
FRONT AXLE PIVOT BUSHING & RADIUS ROD BUSHINGS 9
FRONT BUMPER RELATED PARTS 49
FRONT PARKING BRAKE CABLE 8
FRONT SHACKLE KIT & RELATED PARTS 14
FRONT SPRINGS 13, 14
FRONT SPRING SHACKLE KIT 13
FUEL PUMPS -NEW 29

G

GAS TANK CAP 28
GAS TANK RELATED PARTS 28
GEAR SHIFT INDICATOR DIAL 43
GENERATOR PARTS 31
GLOVE BOX 52, 53
Grease Seal 4

H

HARMONIC BALANCER 19
HEADLIGHT DIMMER SWITCH 41
HEADLIGHT PARTS 37, 38
HEADLIGHT SWITCHES 34
HEADLINER CLIP 61
HEADLINER KITS 60
HEATER PARTS 51
HEATER & RADIATOR HOSE CLAMPS 27
HOOD PARTS 44, 45, 46
HORN BUTTON 42
HORN PARTS 12
HORN RELAY 42
HOUSING PARTS 46
HUB 4

I

IGNITION 36, 37
IGNITION SWITCHES 33
IGNITION SYSTEM 35
INSIDE DOOR HANDLE SHAFT REPAIR KIT 58
INTERIOR DECALS 66

K

KEY BLANKS 12
KING PIN BOLT SET 9

L

LICENSE PLATE BOLT 70
LICENSE PLATE BRACKET 40

M

MANIFOLD GASKET SET 17
MASTER CYLINDER ASSEMBLY 7

MASTER CYLINDER REPAIR KIT 7
MECHANICAL 15
MIRROR ASSEMBLY 46, 47
MISCELLANEOUS 64
MISCELLANEOUS BRAKE PARTS 5
MISCELLANEOUS ITEMS 66, 67
Motor Mount Lower Insulator 16
MOTOR MOUNTS 15, 16

O

OIL BREATHER CAP 23
OIL FILTER ASSEMBLY 23
OIL FILTERS 23
OIL PAN DRAIN PLUG & GASKET 22
OIL PAN GASKET SET 17
OIL PRESSURE SENDING UNITS 23
OIL PUMP ASSEMBLIES 22
OIL PUMP RELATED 22
OPERATORS MANUALS 68
OUTER BEAUTY RINGS 50
OUTSIDE DOOR HANDLE CUSTOM CAB NAME PLATES 54
OUTSIDE DOOR HANDLES 58
OVERDRIVE PULL CABLE GROMMET 52
OVERHAUL GASKET SET 17

P

PARKING BRAKE CABLE 8
PARK LIGHT ASSEMBLY 38
PARK LIGHT PARTS 38, 39
PINS & BUSHINGS 13, 14
PINS & BUSHINGS -F100 & F250 FRONT SPRINGS 14
PISTONS 18
PISTONS & RINGS 18
PIVOT BUSHING 9

R

RADIATOR CAP 26
RADIATOR GRILLE PARTS 27
RADIATOR PAD KIT 26
RADIO ANTENNA 51
RADIO RELATED PARTS 51
RADIUS ARM KIT 10
RADIUS ROD BUSHINGS 9, 10
REAR AXLE PARTS 12
REAR BUMPER 50
REAR CAB MOULDINGS 59
REAR FENDERS 44
Rear Motor Mount Lower Insulator 16
REAR PARKING BRAKE CABLE 8
REAR SPRING PINS & BUSHINGS 14, 15
REAR SPRING SHACKLE KIT 14
REAR VIEW MIRROR ASSEMBLY 46, 47
Ring Gear and Pinion Set 12

ORDERS ONLY 1-800-417-3347

RING INDEX PLATE 42

RINGS 18

ROCKER PANELS 70, 71

Rod Bearings 18

S

SCUFF PLATES 54

Seal 54

SEALS 44, 54

SHOCK ABSORBERS 50

SHOP MANUALS 67

SPARK PLUGS & WIRES 37

SPEEDOMETER CABLE 46

Speedometer Gear 47

SPRING PINS & BUSHINGS 15

SPRING SHACKLE KIT 13

STANDARD TRANSMISSION RELATED PARTS 23, 24

STARTER ASSEMBLY & RELATED PARTS 32, 33

STARTER RING GEAR 26

STEERING COLUMN TO FLOOR SEALS 10

STEERING PARTS 10, 11

STEERING WHEEL 11

Steering Wheel Nut 66

STEP SIDE BED PARTS 61

STRIKER PLATES & RELATED PARTS 56, 57

SUN VISOR BRACKET & ARM 53

SUN VISOR RELATED 53

T

TAILGATE & RELATED PARTS 62

TAIL LIGHT 39, 40

TAIL LIGHT RELATED PARTS 40

TAILLIGHT WITH BACK UP LIGHT 40

TAILPIPE 13

THERMOSTAT GASKETS & HOUSING 27

THERMOSTATS 27

TIE ROD ENDS 9

TIMING CHAIN 19

TRANSMISSION GEAR SHIFT INDICATOR DIAL 43

TRANSMISSION RELATED PARTS 23, 24

TURN SIGNAL RELATED PARTS 39

U

UNIVERSAL JOINTS 23

V

VALVE COVER DECALS 65

VALVE COVER GASKET SET 17

VALVE GRIND GASKET SET 17

VALVES & RELATED 20, 21, 22

VENT WINDOW PARTS 54, 55

VOLTAGE REGULATOR 32

W

WASHER RESERVOIR PARTS 49

WATER PUMPS -NEW 27

WATER PUMPS -REBUILT 27

WELD-IN ROCKER PANELS 70

WHEEL 4

WHEEL AXLE BEARINGS & SEALS 4, 5

WHEEL CYLINDER ASSEMBLY 6

WHEEL CYLINDER REPAIR KITS 6

Window Crank Handle, 57

WINDOW REGULATOR SHAFT REPAIR KIT 58

WINDOW RUBBER 59

WINDOW SHADES 50

WINDSHIELD RUBBER 52

WINDSHIELD WASHER RESERVOIR PARTS 49

WIPER ARMS, BLADES, & RELATED 48

WIPER MOTOR 48

WIPER MOTOR SWITCH 48

WIPER PIVOT PARTS 49

WIRES 37

WIRING 43

WIRING DIAGRAM MANUAL 68

Early Ford D-8 Sales, Inc.

Passenger & Pickups 1928-1966

New Clutch Overhaul Kit

164.95

All New Components, Includes:
New Pressure Plate, Disc
Throwout Bearings &
Pilot Bearings.



No Core Charges

(10") 42-48 Pass., 42-64 Pickups, 19A-7563-KIT

(11") 35-64 Pass & Pickup, 51-7563-KIT

Brake Overhaul Kit

224.95

B7C-2001-KIT Fits 1957-60 F-1 1/2 Ton P/up

C1TZ-2001-KIT Fits 1961-64 F-1 1/2 Ton P/up

Includes: Relined Brake Shoes for 4 wheels,

4 New Wheel Cylinders, Front &

Rear Brake Hoses, 12 New Shoe Return

Springs. & 8 Shoe Retainers.

Add a New master Cylinder for only \$79.95

(No Core Required on Brake Shoes)



Early Ford
U-8 Sales, Inc.
101 Hollow Drive
Piedmont, SC 29673
Earlyfordsouth@msn.com
(864)-845-7848
Fax (864) 845-7886

Early Ford
U-8 Sales, Inc.

Antique, Classic Car & Collectable Automobiles

View our current inventory at WWW.EARLYFORD.COM

Passenger & Pickups 1928-1966

Genuine Parts &
Quality Reproductions

*We remain
committed to
purchasing &
reselling only the
best quality in
antique, classic car,
and collectable
automobiles.*

*While taking great pride in our
efforts to find vehicles that will
retain investment value and
perform to your expectations, we
generally have a selection of
Early Fords available. Typically
we favor complete restored or
original cars of High Quality.*

*We also purchase Quality
Vehicles. If you have a car or
truck you may wish to sell,
please call us.*



Passenger & Pickups 1928-1966

www.EarlyFord.com

We are a full line supplier of the best reproduction parts.

Engine Parts, Wiring
Brakes, Chassis
Transmission
and More.

Call for a Free Catalog



FAST SHIPPING • FRIENDLY TECH HELP

1-800-417-3347 • 864-845-7878 email: earlyfordsouth@msn.com

Early Ford U-8 Sales, Inc.
Piedmont, SC.
Dealer Inquiries Invited